

THE SCIENCE  OF SURVIVAL



EMERGENCY POSITION INDICATING RADIO BEACON WITH RLS

Models Covered

- GlobalFix V6 Category 1 EPIRB
- GlobalFix V6 Category 2 EPIRB
- GlobalFIX V6 Class 3 EPIRB

English

USER MANUAL



GlobalFix V6 User Manual



© 2023 ACR Electronics Inc.

The technical data, information and illustrations contained in this manual were believed to be correct at the time of print. ACR Electronics Inc. reserve the right to change specifications and other information contained in this manual as part of our continual improvement process.

No part of this manual may be reproduced, stored in a retrieval system or transmitted in any form, electronic or otherwise, without the prior permission of ACR Electronics Inc.

No liability can be accepted for any inaccuracies or omissions in this manual.

GlobalFix® is a registered trademarks of ACR Electronics Inc.

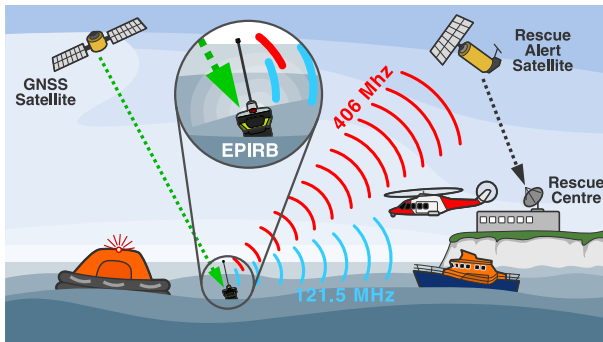

For ease of access please record details of your GlobalFix V6 here:

Owners Name:

Vessel Name:

Beacon HEX ID (UIN):



IN CASE OF EMERGENCY



USE ONLY IN SITUATIONS OF GRAVE AND IMMINENT DANGER

DEPLOYING YOUR BEACON

Category 1 (Automatic or Manual Deployment)

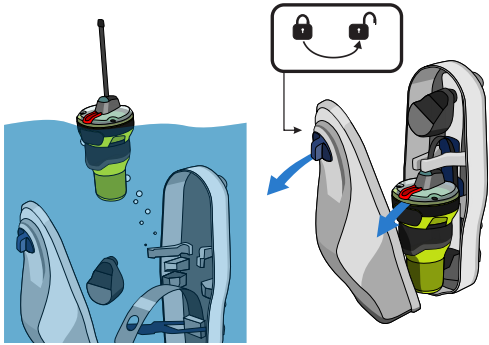

Category 2 (Manual Deployment Only)

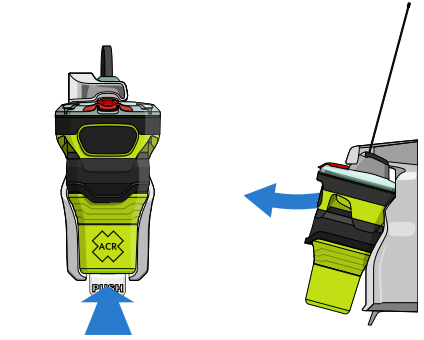

OR

IN A NON-EVACUATION EMERGENCY - THE BEACON CAN ALSO BE MANUALLY DEPLOYED FROM EITHER BRACKET AND MANUALLY ACTIVATED USING THE ON/OFF  KEY

ACTIVATING YOUR BEACON

Manual Activation



The white strobe  will start flashing as an indication of activation.

Refer to page 15 for full LED indications.

Water Activation

 NOT Class 3 Beacon

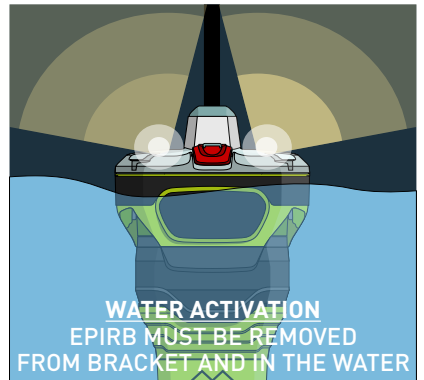

Attach the beacon to your wrist, life jacket or life raft using the lanyard.

DO NOT attach the beacon to a sinking or abandoned vessel.



1. ABOUT YOUR EPIRB

1.1 COSPAS/SARSAT System

The basic Cospas-Sarsat concept is illustrated in the figure below.

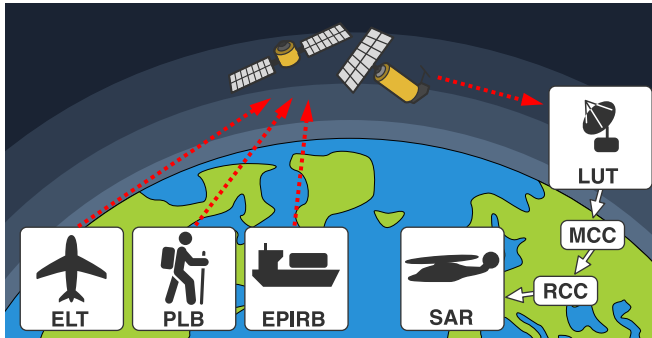

The System is composed of:

- distress radio beacons (ELTs for aviation use, EPIRBs for maritime use, and PLBs for personal use) which transmit signals during distress situations
- instruments on board satellites in geostationary and low-altitude Earth orbits which detect the signals transmitted by distress radio beacons
- ground receiving stations, referred to as Local User Terminals (LUTs), which receive and process the satellite downlink signal to generate distress alerts
- Mission Control Centers (MCCs) which receive alerts produced by LUTs and forward them to Rescue Coordination Centers (RCCs), Search and Rescue Points Of Contacts (SPOCs) or other MCCs

The Cospas-Sarsat System includes two types of satellites:

- satellites in low-altitude Earth orbit (LEO) which form the LEOSAR System
- satellites in geostationary Earth orbit (GEO) which form the GEOSAR System

The future Cospas-Sarsat System will include a new type of satellite in the medium-altitude Earth orbit (MEO) which will form the MEOSAR System. The GlobalFix V6 is fully compatible with the new MEOSAR satellites.



GlobalFix V6 User Manual

1.2 Return Link Service

The Galileo Return Link Service (RLS) is a free-of-charge global service available to Cospas-Sarsat RLS compatible beacons. The new functionality, currently offered uniquely by Galileo, enables a communication link that relays a Return Link Message (RLM) back to the originating beacon through the Galileo Navigation Signal in Space.

The RLS feature is an indication on the GlobalFix V6 that confirms to the User that the distress signal from the EPIRB has been localised by the Cospas-Sarsat system and is being sent to the SAR authorities. It does NOT mean that a search and rescue mission has been launched, but only confirms that the distress alert has been received by the Cospas-Sarsat system and is being routed to the appropriate SAR agencies.

The RLS aims to send an acknowledgment to the beacon within 30 minutes following activation (the response may not be received by the beacon for significantly longer).

RLS is an optional function and may not be permitted in all countries.

The full RLS specification can be found here:

<https://gsc-europa.eu/sites/default/files/sites/all/files/Galileo-SAR-SDD.pdf>

1.3 The GlobalFix V6 Range

1.3.1 GlobalFix V6 Category 1 (Part No. 2853)

This EPIRB combines 406MHz Cospas-Sarsat distress beacon with RLS in a Category 1 Auto Release Housing. This unit will auto-activate in contact with the water.

1.3.2 GlobalFix V6 Category 2 (Part No. 2854)

This EPIRB combines 406MHz Cospas-Sarsat distress beacon with RLS in a Category 2 Manual Release Bracket. This unit will auto-activate in contact with the water.

1.3.3 GlobalFix V6 Class3 (Part No. 2855)

This EPIRB combines 406MHz Cospas-Sarsat distress beacon with RLS in a Category 2 Manual Release Bracket. This unit is Manual activation only.



GlobalFix V6 User Manual

1.	ABOUT YOUR EPIRB	4
1.1	COSPAS/SARSAT System	4
1.2	Return Link Service	5
1.3	The GlobalFix V6 Range	5
2.	GENERAL	7
2.1	Introduction	7
2.2	Exposure to RF Electromagnetic Energy	7
2.3	Warnings	7
2.4	What's in the Box	8
2.5	Operating Modes	8
3.	GLOBALFIX V6 OVERVIEW	9
4.	INSTALLATION	10
4.1	Location	10
4.2	Removal from and Re-fitting to the Automatic Release Housing	10
4.3	Removal from and Re-fitting to the Manual Mounting Bracket	12
4.4	Fit the Manual Mounting Bracket	12
5.	OPERATION	13
5.1	Manual Release	13
5.2	Optical Indications on activation	15
5.3	Deactivation	16
6.	FALSE ALERTS	16
7.	TESTING	17
7.1	NFC and Mobile App.	17
7.2	Beacon Test	18
8.	BEACON REGISTRATION	20
8.1	Advice to owners of EPIRBs	20
8.2	Country Specific Registration Information	20
8.3	UNREGISTERED BEACON	21
9.	APPENDIX	21
9.1	Maintenance and Troubleshooting	21
9.2	Batteries	22
9.3	Decommissioning and Disposal	23
9.4	Transport	23
9.5	HydroFix HRU Replacement	24
9.6	Specifications	25
9.7	Approvals	26
9.8	Spares	26
10.	WARRANTY INFORMATION	27
10.1	Limited Warranty	27
10.2	Extended Warranty	27



GlobalFix V6 User Manual

2. GENERAL

2.1 Introduction









This manual provides valuable information for the installation, operation and routine maintenance of the GlobalFix V6.

Please read this manual completely before using your GlobalFix V6.

2.2 Exposure to RF Electromagnetic Energy

This product complies with EN62479 (EU) and RSS-102 (Canada).

2.3 Warnings

-  **It is a legal requirement to register your GlobalFix V6 with your National Authority.**
-  **Only use your GlobalFix V6 in a situation of grave and imminent danger.**
-  **Deliberately misusing your GlobalFix V6 or setting it off accidentally may result in prosecution and a fine.**
-  **Contains Lithium batteries:**
 - **store between -30°C (-22°F) to +70°C (+158°F)**
If the GlobalFix V6 is stored at higher temperatures the battery life may be degraded and should be replaced earlier than the date stated. Failure to do this may result in the GlobalFix V6 not fulfilling the stated 48hr operating life. The effect is more pronounced as the temperature increases.
 - **DO NOT ATTEMPT TO REPLACE THE BATTERIES YOURSELF**
unauthorised opening and battery replacement may put your life at risk.
 - **do not short circuit, incinerate or recharge.**
-  **Please see section 9.4 for information on safe transportation.**
-  **The battery in your GlobalFix V6 should be replaced immediately if it has been activated, or if the test indicator shows the battery as 'used', or if the expiry date marked on the unit has been exceeded.**
-  **Battery replacement must be carried out at an ACR authorised battery replacement center using manufacturer supplied battery components. The GlobalFix V6 Category 1 is supplied with an automatic release housing for external installation only. See the installation guidelines in section 4 for further information.**
-  **Please read these instructions carefully. Failure to follow the guidance in this manual may result in loss of warranty.**



GlobalFix V6 User Manual

2.4 What's in the Box

1. Mounting Bracket (see options)
2. GlobalFix V6
3. User Guide & Labels pack
4. Mounting Screws (x3 for Cat 2) (x6 for Cat 1)



2.5 Operating Modes

Your GlobalFix V6 may be operated in a variety of modes.

2.5.1 Automatic activation



Should the vessel be in danger of sinking the GlobalFix V6 should be removed from its bracket and placed in the sea. Contact with the water will automatically activate the GlobalFix V6.

⚠ The Class 3 unit is not water activated and MUST be manually activated before placing in water.

2.5.2 Manual activation on deck



When deploying the GlobalFix V6 on a deck, ensure it is vertical and clear of obstructions that might impede a clear view of the sky.

2.5.3 Manual activation in a life raft



The GlobalFix V6 may be deployed in a life-raft, where it should be held in a vertical position so that there is a clear view of the sky, preferably outside of the canopy. The GlobalFix V6 can also be tethered to the life-raft and allowed to float alongside.

3. GLOBALFIX V6 OVERVIEW

- 1) **ON/OFF** Key (Under flap)
- 2) Indicator LED
- 3) Antenna
- 4) Strobe light (internal)
- 5) **TEST** Key
- 6) NFC Antenna
- 7) Witness Label
- 8) Lanyard under rubber band
- 9) Programming Details Label (behind)
- 10) Category 1 Bracket
- 11) Category 2 Bracket

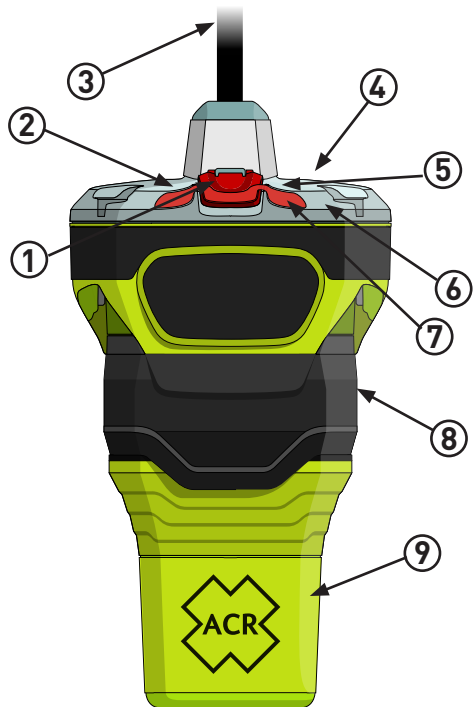

⚠ The lanyard is provided to attach the GlobalFix V6 to the life raft or your person, once it is activated. Do not use it to attach it to the vessel, as this may result in the loss of the GlobalFix V6 if the vessel sinks.

⚠ It is important that the vessel details are marked on the GlobalFix V6. Please use a fine tip UV resistant indelible pen to clearly mark the MMSI, Vessel Name and Call Sign in the spaces provided. Cover this label with the clear protective label provided to protect the text from wear.

10

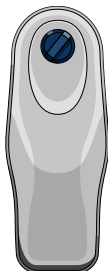

11

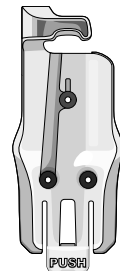



GlobalFix V6 User Manual

4. INSTALLATION

- ⚠ Failure to follow the following installation guidelines may cause the GlobalFix V6 to operate incorrectly.
- ⚠ Do not mount the GlobalFix V6 closer than 1.0 metre to any steering compass as this may affect the accuracy of the compass.
- ⚠ Keep the GlobalFix V6 away from any strong magnetic sources such as loudspeakers, compass compensation magnets, etc.
- ⚠ Do not install or operate in a location subject to high intensity RF fields (e.g. radar or communications antennas)
- ⚠ GNSS operation may be impaired if operated within 10m of GMDSS sat-com systems.

4.1 Location

The location selected must be sufficiently robust to support the weight of the entire unit. Exposure to the elements and surrounding hazards along with vibration should also be taken into consideration when choosing the location. Ensure that the mounting location allows easy access to the GlobalFix V6 for emergency use, maintenance and servicing. Ensure that a Category 1 housing is installed to a vertical surface where the beacon can float free from the sinking vessel.

4.2 Removal from and Re-fitting to the Automatic Release Housing

- ⚠ DO NOT install a Class 3 EPIRB in the Automatic Release Housing

To access the bracket's five pre-drilled mounting holes, remove the bracket's lid by turning the spring loaded knob on the lid 1/4 turn clockwise and pulling. The lid will lift away from the top of the base and disengage at the bottom of the base. The lid is tethered to the base to help prevent loss. (If this tether is somehow broken off, please have it replaced to prevent the inadvertent loss of the top cover.)

Pull the beacon with steady pressure from the bracket. For normal use situations, four of the five holes can be used to mount the bracket. It is therefore not necessary to remove the HydroFix HRU to mount the bracket using all five holes.

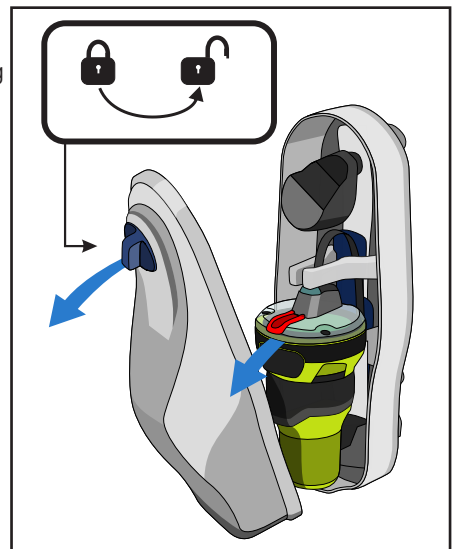

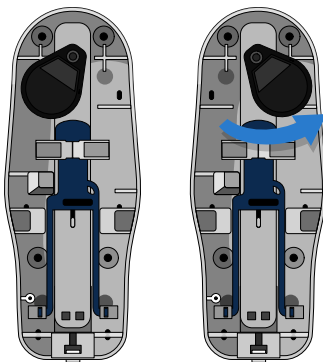

For extreme use situations, remove the HydroFix HRU and deploy the ejector spring for access to the fifth mounting hole.

Hold the bracket in place to mark the screw holes or use the provided mounting template.

The use of #10 pan head stainless steel fasteners [minimum of ½" (1.27 cm) long] and #10 ½" (1.27 cm) washers is recommended.



GlobalFix V6 User Manual

4.3 Removal from and Re-fitting to the Manual Mounting Bracket



- 1) Press the tab marked PUSH to release the GlobalFix V6 from the Manual Bracket.

- 2) Place the antenna into the slot on the bracket and insert the top of the GlobalFix V6 into the bracket. Push the bottom into the bracket until a click is heard



4.4 Fit the Manual Mounting Bracket

Using the dimensions shown, use the three No10 x 1" screws supplied to secure the Manual Bracket to a suitable bulkhead in a position that will allow easy access in the event of abandoning the vessel.

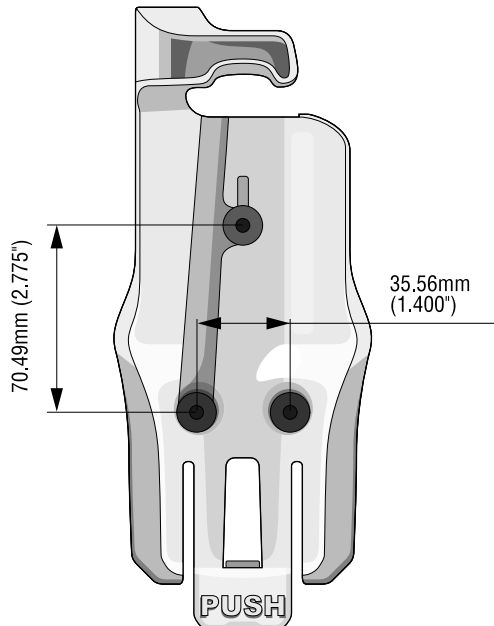

IN CASE OF EMERGENCY



**USE ONLY IN SITUATIONS OF
GRAVE AND IMMINENT DANGER**



5. OPERATION

The GlobalFix V6 is designed for best operation while floating in water. If used in other situations ensure that the GlobalFix V6 is placed in the open, clear of any cover and kept upright. Do not place the GlobalFix V6 close to large structures or under cover.

In the event of the vessel starting to sink the GlobalFix V6 Category 2 EPIRB **MUST** be released from the Manual Bracket and placed in the water, it will activate on contact with the water. The GlobalFix V6 Category 1 unit will auto deploy in the event of the vessel sinking. The GlobalFix V6 Class 3 **MUST** be released from the bracket and activated manually.

In the case of abandoning a ship, if possible, recover the GlobalFix V6 and tie to the survival craft or person using the lanyard. For optimum operation, it is recommended that the GlobalFix V6 be tied to a life-raft with the lanyard and floated in the sea.

 **The GlobalFix V6 is prevented from auto activation while mounted in the Manual Bracket or Automatic Release Housing. For activation the GlobalFix V6 MUST be removed from either bracket allowing the antenna to deploy fully.**

5.1 Manual Release

5.1.1 Remove from the Manual Bracket



- Press the tab marked PUSH and pull the GlobalFix V6 EPIRB away from the bracket
- Release the lanyard and attach it securely to yourself or the life-raft



DO NOT ATTACH THE BEACON TO THE VESSEL AS THIS MAY SINK SUBMERGING THE BEACON OR YOU MAY DRIFT AWAY FROM THE VESSEL



GlobalFix V6 User Manual

5.1.2 Lift the red flap breaking the witness seal

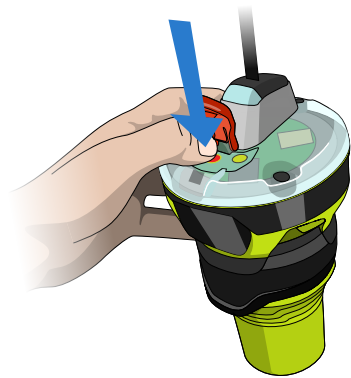

DO NOT LEAVE THE BEACON IN THE CATEGORY 2 BRACKET IF THE VESSEL IS IN DANGER OF SINKING

5.1.3 Press and hold the red button for 1 to 2 seconds to activate. (Until the green LED starts to flash)

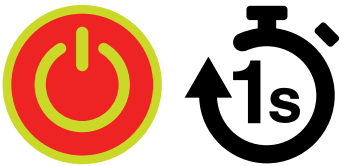

The GlobalFix V6 will now be operational. The strobe lights will begin to flash at a rate of once every 2.5 seconds as soon as the unit is activated.

For best performance it is important that the GlobalFix V6 is in an upright position with a clear view of the sky and as far away from any metallic structures as possible.

The GlobalFix V6 contains a GNSS receiver. Ensure that the GNSS antenna is not obstructed and has a complete, unobstructed view of the sky – as indicated on the top of the GlobalFix V6.

A lanyard is provided to tether the GlobalFix V6 to the lifeboat or life raft to ensure that it does not drift away. Make sure this is firmly attached.



5.1.4 GlobalFix V6 Automatic Operation (NOT Class 3 version)

The GlobalFix V6 will sense when it has been placed in water and automatically begin to operate after a short delay, in the same manner as described above.









If the GlobalFix V6 is mounted in the Manual Bracket or Auto Release Housing this function is disabled until the GlobalFix V6 has been released.







5.2 Optical Indications on activation

- The LED will illuminate green  (blue  if RLS is enabled) for 1 second.
- The strobe light  will start flashing.
- Within 1 minute of activation, the indicator LED will flash a quick burst of 5 indicating 406MHz transmission.

5.2.1 LED Indications with RLS Enabled

LED	When	Transmit	GNSS	RLS
(x1) 	Every 5 s		Searching	
(x3) 	Once		Fix acquired	
(x5) 	At transmit	406MHz	No Fix	Request sent
(x5) 	At transmit	406MHz	Fix acquired	Request sent
(x1) 	Every 2.5 s*	121MHz		Reply not received
(x1) 	Every 2.5 s*	121MHz		Reply received
(x1) 	Every 2.5 s			

5.2.2 LED Indications for units configured with non-RLS Protocol

LED	When	Transmit	GNSS
(x1) 	Every 5 s		Searching
(x3) 	Once		Fix acquired
(x5) 	At transmit	406MHz	No Fix
(x5) 	At transmit	406MHz	Fix acquired
(x1) 	Every 2.5 s*	121MHz	
(x1) 	Every 2.5 s		

* The 121MHz Homer will not transmit until after the first 406MHz transmission.



GlobalFix V6 User Manual

5.3 Deactivation

5.3.1 Deactivation if Manually Activated

If the GlobalFix V6 has been inadvertently activated or the emergency situation has passed, it can be turned off simply by pressing and holding for 1 to 2 seconds the ON/OFF  key. It is not possible for the user to replace the red protective cover. Return the GlobalFix V6 to an ACR authorised service center for checking and replacement.

5.3.2 Deactivation if Automatically Activated (NOT Class 3 version)

If the GlobalFix V6 was automatically activated by placing in water, remove from the water and dry. The GlobalFix V6 will automatically switch off after approximately 30 seconds.

6. FALSE ALERTS

False alerts are a serious problem - they cause valuable resources to be diverted away from real emergency situations. If a false alert is initiated, by any means, it is important to contact the nearest search and rescue authority and inform them of the false alert.

Report the following information:

1. GlobalFix V6 Hex ID.
2. Date, time and duration.
3. Cause of activation.
4. Location when the alert was activated.
5. Location at time of deactivation.

If the GlobalFix V6 was activated by mistake then turn it off. The first emergency transmission will not occur for approximately 50 seconds. If the unit is turned off within this time then GlobalFix V6 will not have sent an emergency distress alert.

The GlobalFix V6 is fitted with water activation contacts. Although the float free housing is designed to prevent accidental activation in heavy seas and adverse weather conditions, if the GlobalFix V6 is not correctly fitted in its housing it is possible that this may cause a false alert situation.

If the unit has been dropped into the water then remove from the water and dry the case. Wait approximately 30 seconds for the water contacts to de-activate. If the unit is still flashing after this period, check that the unit has not been manually activated; if so then follow the procedure to manually switch the GlobalFix V6 off.

Once the GlobalFix V6 is switched off, it is advisable to carry out a self test before replacing the GlobalFix V6 into the Float Free Housing or Manual Bracket.



Should the GlobalFix V6 fail to deactivate, bend the antenna down and completely wrap in several layers of aluminum foil , or place in a metal container with a tightly fitting lid.



GlobalFix V6 User Manual

7. TESTING

Routine testing of your GlobalFix V6 is recommended to ensure it is in good working order if needed in an emergency. Monthly testing is recommended, but remember that each test will reduce the battery capacity slightly and reduce the operating time of your GlobalFix V6 during an emergency.

7.1 NFC and Mobile App.

The GlobalFix V6 is capable of connection to devices using Near Field Communication (NFC). NFC technology allows communication between two electronic devices over a distance of 4cm (1.5”) or less. The benefit of using NFC in the GlobalFix V6 is that the power used for communication comes from the mobile device and not the beacon.

The ACR Mobile App allows a user to access the GlobalFix V6 and see the programmed details and the latest test results giving a clear indication of the beacon’s condition.

Download the App. here: Android  iOS 





To use the App touch your mobile device to the top of the GlobalFix V6 where you see “NFC”.









GlobalFix V6 User Manual

7.2 Beacon Test











-  Ensure the antenna is free and above the GlobalFix V6 before commencing the test. Fold the antenna back behind the EPIRB as you replace it in the housing.
-  Because the test transmits a short burst on the aircraft distress frequency of 121.5MHz, please only carry out this test in the first five minutes of each hour.
-  It is recommended to test your GlobalFix V6 once a month.
-  A magenta or amber test result indicates the battery has been used for over two hours or the recommended number of tests has been exceeded. The GlobalFix V6 will still operate normally in distress, but the battery should be replaced to ensure the full operating life when your GlobalFix V6 is needed.

7.2.1 Functional Test











To test your GlobalFix V6 is functioning correctly, press and hold the TEST  key for 1 to 2 seconds. The LED will illuminate red  to indicate the key has been pressed, then start flashing. Release the TEST  key now. After a short pause the strobe  will flash and the indicator LED will produce a flash sequence.

The flash sequence indicates the total number of hours that the battery has already been in use, up to the time that the test was initiated.

7.2.2 LED Indications with RLS Enabled

No. of Flashes	Functional Test Pass	Fail
1	0 to 59min  1hr to 1hr 59min 	121.5MHz homer 
2	2hrs to 3hrs 59min 	406MHz power 
3	4hrs to 5hrs 59min 	
4	6hrs to 7hrs 59min 	
5	8hrs to 9hrs 59min 	Battery failure 
6	10hrs + 	No GNSS 

7.2.3 LED Indications for units configured with non-RLS Protocol

No. of Flashes	Functional Test Pass	Fail
1	0 to 59min  1hr to 1hr 59min 	121.5MHz homer 
2	2hrs to 3hrs 59min 	406MHz power 
3	4hrs to 5hrs 59min 	
4	6hrs to 7hrs 59min 	
5	8hrs to 9hrs 59min 	Battery failure 
6	10hrs + 	No GNSS 



GlobalFix V6 User Manual

 The battery must be replaced either prior to the expiry date shown on the rear label or after the GlobalFix V6 has been activated.





 If, during a self test, the LED flashes magenta  or amber  the GlobalFix V6 may not have sufficient energy to operate for the specified 48-hour period. Battery replacement is recommended.



NOTE: The flash sequence will be repeated after a short pause and then the GlobalFix V6 will automatically power off.



7.2.4 GNSS Test

 This test should only be performed where the GlobalFix V6 has a clear and unobstructed view of the sky. This is required to allow the GNSS receiver to acquire a signal from sufficient satellites to allow it to determine a position. Ensure the area marked “GNSS Antenna” is not obstructed.

It is recommended that a GNSS test is carried out at least once every six months to ensure correct operation of the GlobalFix V6.

Press and hold the TEST  key for 5 seconds. The LED will illuminate red  to indicate the key has been pressed, then start flashing. Shortly after, the LED will cease flashing and become a steady red  light. Release the TEST  key now.



During the GNSS test the LED will repeat a long red  flash followed by a short green  flash until either a position fix is obtained or the GNSS test fails.

A successful test will be indicated by a number of green  LED flashes and an unsuccessful test will be indicated by a number of red  LED flashes. The number of flashes indicates the number of GNSS tests remaining (e.g. 7 flashes = 7 tests remaining).

The test result flashes will be repeated after 2 seconds.

If there are 10 or more tests remaining then the LED will flash 10 times only (repeated).

The GlobalFix V6 has the capacity to carry out 60 GNSS tests within the lifetime of the battery.

If there are no tests remaining immediately after the current test, the LED will flash green  or red  rapidly for three seconds (not repeated) depending on whether the GNSS test was successful or not, respectively.

When there are no tests remaining, the LED will flash red  rapidly for three seconds (not repeated).

The test can be ended at any time by holding the TEST  key for 1 to 2 seconds.

For further information regarding Self Test and Self Test history use the ACR Mobile App to connect to your GlobalFix V6 using Near Field Communication (NFC).

Android



iOS





8. BEACON REGISTRATION

! It is the owner's responsibility to register this beacon with the appropriate National Authority before operation.

Documentation is provided within the packaging with information regarding registration with the relevant body to comply with the required configuration of the beacon.

NOTE: For all countries listed below it is preferred that registration is completed on-line using the appropriate links.

8.1 Advice to owners of EPIRBs

Registration of 406 MHz satellite EPIRBs:

- Registration with the National Authority is mandatory because of the global alerting nature of the system.
- The information provided in the registration card is used for rescue purposes only.
- See the owner registration card for the National Authority contact details on how to register your beacon upon completion of the sales transaction. Before a beacon enters service, it should be registered with the National Authority.
- If the beacon is being transferred to a new owner, the current owner needs to inform the National Authority of the name and address of the new owner.
- The subsequent owner of the beacon is required to provide the National Authority with the information as shown in the owner registration card.
- This obligation transfers to all subsequent owners.

8.2 Country Specific Registration Information

USA

NOAA-Sarsat, USMCC, NSOF, E/SP053, 1315 East West Hwy, Silver Spring, MD, 20910
Fax: (1.301) 8174565, Tel: (1.301) 8174515 (1.888) 2127283
Email: beacon.registration@noaa.gov, Web: www.beaconregistration.noaa.gov/

CANADA

Beacon Registry, CMCC Trenton, 8 Wing Trenton, Box 1000 Stn Forces, Astra, Ontario, K0K 3W0
Fax: +1 877 406 3298, Tel: +1 800 211 8107 / +1 613 965 7265
Email: cbr@sarnet.dnd.ca, Web: www.cbr-rcb.ca

UK

Distress & Security Beacon Registry, Pendennis Point, Castle Drive, Falmouth, TR11 4WZ
Fax: +44 (0) 13 2631 9264, Tel: +44 (0) 20 3817 2006
Email: ukbeacons@mcga.gov.uk, Web: www.gov.uk/406beacon

AUSTRALIA

Australian Maritime Safety Authority, GPO Box 2181, Canberra, Australia, ACT 2601
Fax: 1800 406 329 (+61 2 9332 6323 (Int.)), Tel: 1800 406 406 (+61 2 6279 5766 (Int.))
Email: ausbeacon@amsa.gov.au, Web: www.amsa.gov.au/beacons

NEW ZEALAND

JRCC NZ, Avalon Studios, Percy Cameron Street, P.O. Box 30050, Lower Hutt, 5040
Fax: +64 4 577 8041, Tel: +64 4 577 8030 +64 4 577 8034
Email: 406registry@maritimenz.govt.nz, Web: www.beacons.org.nz

For other countries visit: www.406registration.com/countriesupported.aspx



8.3 UNREGISTERED BEACON

-  **It is important to register your beacon. Operation of a beacon that is unregistered or incorrectly registered could lead to delays in providing the rescue services required by the operator of that beacon.**

9. APPENDIX

9.1 Maintenance and Troubleshooting

EPIRBs require little maintenance except periodic cleaning, if required. Always use a damp cloth to clean the case and dry thoroughly.

-  **Do not use solvents or other cleaning fluids as this may cause the plastics to deteriorate.**
-  **Ensure the antenna is clean and not permanently bent.**
-  **Should the EPIRB turn on during cleaning, make sure it is turned off as quickly as possible by pressing and holding the ON/OFF Key until the LED flashes red twice and release.**

9.1.1 Every Month

During the EPIRB self test it is advised that the following inspection is performed.

- Inspect the EPIRB for obvious signs of damage including the state of the antenna. Any creases in the antenna may cause operation of the EPIRB to be impaired.
- Confirm that the EPIRB is securely mounted on the Manual Bracket or in the Float Free Housing.
- Inspect the lanyard to ensure it is not attached to any structures.
- Confirm the battery is within the specified expiry date.
- For Category 1 variant confirm the HRU is within the specified expiry date (Two years after the installation date).
- Clean the EPIRB and mounting. It is recommended that the EPIRB is cleaned only using a damp cloth.

9.1.2 Every 12 Months

- Annual Test and Inspection:
Perform extended annual test according to IMO's MSC/Circ.1040 of 406 MHz satellite EPIRBs as required by SOLAS IV/15.9 (If required by SOLAS or national regulation)
- Perform a GNSS Test (see section 7.2)



GlobalFix V6 User Manual

9.1.3 Shore Based Maintenance (SBM)

- If the EPIRB is fitted on a vessel which requires GMDSS compliant equipment, the EPIRB shall be serviced, tested and approved as required by SOLAS regulation IV/15.9.2 of SOLAS 1974 as amended with, in accordance with MSC/Circ.1039 guidelines for shore-based maintenance of Satellite EPIRBs within 5 years, or by the date of battery expiry, whichever comes first.



There are no user serviceable parts inside the GlobalFix V6.



DO NOT OPEN THE EPIRB, DOING SO WILL INVALIDATE THE WARRANTY AND MAY CAUSE FALSE ALERTS

9.2 Batteries

The GlobalFix V6 contains Lithium iron batteries for long operating life. The battery must be replaced either prior to the expiry date or after the GlobalFix V6 has been used, even if only activated for a short period of time. The battery condition can be determined by carrying out the Self Test procedure shown in section 7 of this manual.



Battery replacement must be carried out at an ACR authorised battery replacement center using manufacturer supplied battery components.



DO NOT ATTEMPT TO REPLACE THE BATTERIES YOURSELF

The GlobalFix V6 is a life saving device and unauthorised opening and battery replacement may cause the unit to fail upon activation putting your life at risk.



Contains Lithium batteries:

- store between -30°C (-22°F) to +70°C (+158°F)

If the GlobalFix V6 is stored at higher temperatures the battery life may be degraded and should be replaced earlier than the date stated. Failure to do this may result in the GlobalFix V6 not fulfilling the stated 48hr operating life. The effect is more pronounced as the temperature increases.

**- DO NOT ATTEMPT TO REPLACE THE BATTERIES YOURSELF
unauthorised opening and battery replacement may put
your life at risk.**

- do not short circuit, incinerate or recharge.







Do not short circuit, incinerate or recharge.



GlobalFix V6 User Manual

9.3 Decommissioning and Disposal

Care should be taken when disposing of your GlobalFix V6 when it is no longer required. It is recommended to remove the battery from the GlobalFix V6 by removing the top case and lifting clear the circuit board.

-  **The GlobalFix V6 is not user serviceable and opening the case will invalidate the warranty.**
-  **Once removed, the battery and other components of the product should be disposed of following guidelines and laws applicable within the relevant country.**
-  **Do not short circuit, incinerate or recharge the battery.**
-  **Incorrect handling and disposal of batteries may lead to leakage and explosion.**

It is the owner's responsibility to inform the National Authority under which the beacon was registered that the beacon has been decommissioned.

9.4 Transport

When shipping your GlobalFix V6 the following guidance and regulations should be followed, but you are advised to contact your nearest battery replacement center or ACR prior to shipping as regulations may have changed.

- Always pack your GlobalFix V6 securely in a stout cardboard carton. ACR advises that you keep the original packaging in case of return for service.
- For surface transport the GlobalFix V6 may be shipped under [Special Provision 188](#).
- For air transport the GlobalFix V6 should be shipped as category [UN3091](#) and packed under [ATA packing instruction 970 section II](#). If you are hand carrying your GlobalFix V6 on an aircraft please contact your airline for advice.

Safety Data sheets for all ACR products can be found on the ACR website:

<https://www.acrartex.com/>



GlobalFix V6 User Manual

9.5 HydroFix HRU Replacement

When opening the lid of the Float Free Housing, note that the beacon is installed with the logo facing outward. Pull the beacon with steady pressure from the bracket. Do not get beacon wet while it is out of the bracket. The HydroFix HRU has a keying feature that locks it to the bracket. If you view the HydroFix HRU rod as the center of a clock, a properly installed HydroFix HRU will rest at the 7 o'clock position, as shown in the left-hand picture below.

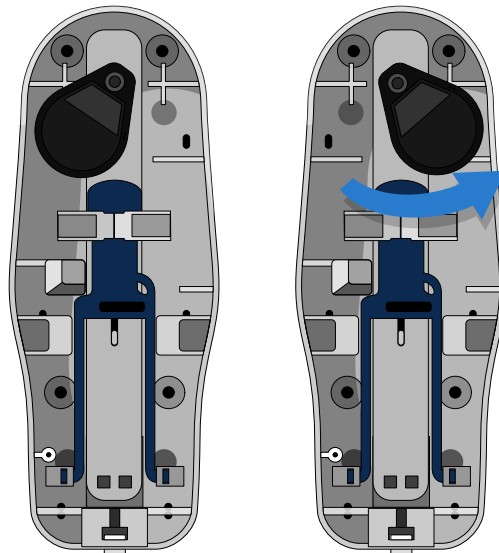

⚠ The HydroFix HRU holds down an ejection spring. The spring must be firmly held in place during the removal and installation of the HydroFix HRU to prevent injury.

Depress the top of the ejection spring. This will relieve pressure on the HydroFix HRU and allow it to be rotated counter-clockwise to the 5 o'clock position as shown in the right-hand picture above. The HydroFix HRU is now free to be removed. Slowly relieve pressure from the ejection spring and allow it to deploy.

⚠ Discard the expired HydroFix HRU. Failure to replace the entire assembly may cause the bracket to malfunction

⚠ Be sure to use only ACR's HydroFix HRU (ACR P/N 9490.1) in the Float Free Housing. Use of unauthorized replacement parts will void your warranty and may cause the bracket to malfunction.

Check the date of manufacture on the new HydroFix HRU. Follow the instructions that accompany the HydroFix HRU for marking the next expiry date and for selecting the correct rod adapter.



GlobalFix V6 User Manual

9.6 Specifications

406MHz Transmitter

Transmit Power (EIRP)	12W
Frequency	406.031 MHz \pm 1KHz
Modulation	Phase \pm 1.1 Radians (16K0G1D)
Encoding	Biphase L
Rate	400 bps

121.5MHz Transmitter

Transmit Power (PERP)	50mW \pm 3dB
Frequency	121.5 MHz
Modulation Duty Cycle	>35%
Modulation Factor	0.85 to1.00
Frequency Stability	\pm 50ppm
Duty Cycle	>98%

Strobe and Night Vision Lights

Light Type	High Intensity LED & Infrared (IR)
Light Color	White and IR
Average Intensity Visible	>1 candela
Average Intensity Night Vision Light	15mW/sr
Flash Rate	24 per minute (nom.)

Battery

Type	Lithium Iron Disulphide (LiFeS ₂)
Operating Time	>48Hours @ -20°C
Battery Replacement Period	10 years

GNSS Receiver

Satellite Channels	72 acquisition
Sensitivity	-167dBm
Cold Start / Re-acquisition	-148dBm / -160dBm
GNSS Antenna	Microstrip Patch

NFC Transmitter/Receiver

Operating Frequency	13.56 MHz
---------------------	-----------



GlobalFix V6 User Manual

General

Dimensions of EPIRB (Inc. antenna)	18.5 x 4.3 x 4.36 in. (470 x 109 x 111 mm)
Weight	1.78 lbs (810g)
Dimensions of Float Free Housing	6.2 x 15.75 x 5.9 in. (157 x 400 x 150 mm)
Weight (Inc. EPIRB)	1,912grams (4.25lbs)
IEC60945 Category	Portable
Operating Temperature	Class 2 -20C to +55C
Storage Temperature	Class 2 -30C to +70C
Waterproof (EPIRB)	10m depth for 1 hour
Auto Release Depth	4m maximum
Expected Life (EPIRB and Bracket)	In excess of 10 years

9.7 Approvals

In addition to Cospas Sarsat Type Acceptance, the GlobalFix V6 complies with the following National Approvals:

9.7.1 European Union

Hereby, ACR Electronics Inc. declares that the radio equipment type RLB-43 is in compliance with Radio Equipment Directive 2014/53/EU.

The DoC can be found at the following website link:



<https://www.acrartex.com/products/globalfix-v6-epirb>

9.7.2 UK

Complies with UK Radio Equipment Regulation (UK RER):2017

9.8 Spares

Manual Mounting Bracket
Float Free Housing (SeaShelter)

Part Number: 9656
Part Number: 2832



10. WARRANTY INFORMATION

10.1 Limited Warranty

Your ACR product is warranted against manufacturing defects in materials and workmanship for a period of 2 years from the date of purchase and in accordance with the following conditions.

ACR will at its discretion, repair or replace faulty product free of charge excluding the cost of shipping. Proof of purchase shall be required in order for a warranty claim to be valid from the original purchaser. All claims shall be made in writing to ACR or an approved service dealer or distributor.

ACR shall not be liable to the buyer under the above warranty:

- for any repairs or modifications carried out on the product using parts that are not supplied or approved by the manufacturer ACR including batteries and for work carried out other than by ACR or approved service dealers,
- for any part, material or accessory that is not manufactured by ACR the consumer will be covered by the guarantee / warranty offered to ACR by the manufacturer or supplier of such a component,
- for product which has not been fully paid for,
- for any product supplied by ACR to a customer under an alternative warranty or commercial agreement,
- for the cost of shipping product to and from the customer.

The Battery is only warranted until the date of expiry and provided the unit is tested in accordance with the information in the user manual as noted by the electronic witness stored within the product. The following specific item is excluded from this warranty:

- Damage to the antenna

This warranty does not affect your statutory rights.

10.2 Extended Warranty



ENTER YOUR PRODUCT DETAILS TO GAIN THE EXTENDED WARRANTY PERIOD

Apply for free at <https://www.acrartex.com/register/>



By entering your product details you can add 3 years to the warranty period. For full details on extended warranty on this product see www.acrartex.com.

For further assistance please contact our Technical Service Department.
Email: techsupport@acrartex.com

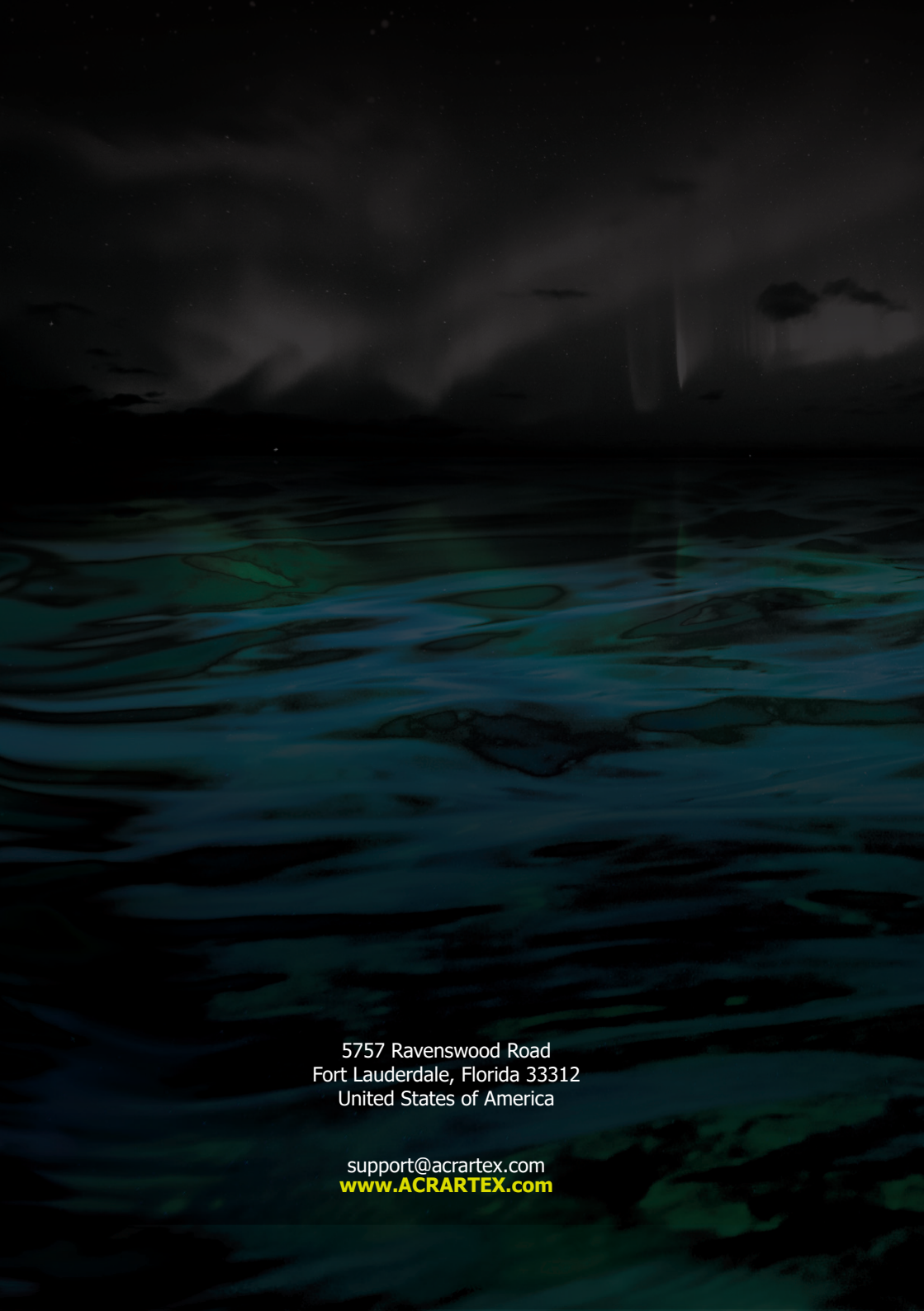

5757 Ravenswood Road
Fort Lauderdale, Florida 33312
United States of America

support@acrartex.com
www.ACRARTEX.com