



SIKA MARINE APPLICATION GUIDE

SIKA MARINE APPLICATION GUIDE

SEALING AND BONDING TECHNOLOGY

06	PREFACE
08	EXPLANATION OF DIFFERENT FIXING METHODS
10	DIFFERENCE BETWEEN RIGID AND ELASTIC ADHESIVES
13	BONDING CONSTRUCTION DESIGN
15	COST ADVANTAGE OF ELASTIC BONDING
17	TIPS AND TRICKS
21	PRODUCT SELECTOR, CALCULATION TOOLS
22	ADHESIVE PRIMER CONSUMPTION
23	CONVERSIONS AND CALCULATIONS
24	QUALITY ASSURANCE
27	PRODUCT DATASHEETS AND SAFETY DATASHEETS

TEAK DECKING

30	GENERAL DESCRIPTION
31	TYPES OF TEAK DECK
31	JOINT DIMENSIONING
33	PROCEDURE OF LEVELLING, BONDING AND CAULKING OF TEAK DECKS
38	PREFABRICATED TEAK DECKS
41	MAINTENANCE OF TEAK DECKS
42	TEAK DECK REPAIR
47	ALTERNATIVES TO TEAK
50	BONDING OF TIMBER ELEMENTS

GENERAL MARINE ELASTIC BONDING APPLICATIONS

54	BEDDING AND SEALING FITTINGS AND HARDWARE
56	BONDING OF RUB RAILS AND FENDERS
58	BONDING DECORATIVE PANELS AND WORK SURFACES
60	BONDING LIGHTWEIGHT INTERNAL PARTITIONS
62	ELASTIC THICK LAYER BONDING

STRUCTURAL BONDING MARINE APPLICATIONS

66	SIKA SOLUTIONS FOR STRUCTURAL BONDING
68	DIRECT GLAZING
71	BONDING AND SEALING ORGANIC WINDOWS
74	BONDING AND SEALING MINERAL GLAZING
77	FLYBRIDGE BONDING
79	DECK AND KEEL TO HULL BONDING

83 GLOSSARY OF TERMS

86 NOTES

SIKA MARINE APPLICATION GUIDE SEALING AND BONDING TECHNOLOGY

CONTENT

- 06** Preface

- 08** Explanation of Different Fixing Methods

- 10** Difference Between Rigid and Elastic Adhesives

- 13** Bonding Construction Design

- 16** Cost Advantage of Elastic Bonding

- 17** Tips and Tricks

- 21** Product Selector, Calculation Tools

- 22** Adhesive Primer Consumption

- 23** Conversions and Calculations

- 24** Quality Assurance

- 27** Product Datasheets and Safety Datasheets





PREFACE

INTRODUCTION

Since the middle of the 17th century, when the industrial revolution began, the process of manufacture has changed dramatically, in methods and materials. At the time, it was state-of-the-art to assemble boats and ships using traditional methods like wood jointing, nailing and screwing. Riveting and welding followed in later years, but today, we are aware of the limitations of these old methods compared to what is currently available. New lightweight materials as well as sandwich structures need smooth, stress concentration free assembly. Today, time, weight, cost, design freedom and reliability are all greatly enhanced by using chemical bonding, sealing and damping products.

BONDING, SEALING AND DAMPING

Sealants and adhesives share a similar technology. Their functions overlap to a large extent, but as they also have a range of other benefits, the role of elastic bonding is not only to join, but also to waterproof, dampen sound,

insulate and prevent galvanic corrosion; all needed to overcome the daily problems in the marine environment. Some products are specifically for bonding as they exhibit high mechanical strength (commonly known as rigid adhesives) and feature variable open time to accommodate everything from quick production rates, to the much slower large structural component assembly. Much of their usefulness in absorbing forces and shock stems from the toughness of the cured bond and this, in turn, is a major factor in the durability and reliability of the bond.

FLEXIBLE BONDING AND SEALING

Flexible bonding and sealing is distinct from bonding with high modulus adhesives. They are applied in a bondline thickness of some millimetres. These products have the high elastic characteristics of both adhesives and sealants. While it does not have the high mechanical strength of rigid bonding adhesives, it has far greater flexibility, which helps to reduce fatigue in the bonded components.

FLOORING AND ACOUSTIC DAMPING

Sub decks are not always smooth and level and besides being generally unattractive, they are responsible for the transmission of most of the noise in cabins and compartments.

Modern flooring has elements that improve the marine environment:

- The deck is levelled and smoothed
- The noise level transmitted through it is reduced
- The cosmetic finish improves the appearance
- Various systems can be used that amplify one or more of these.

Sika works closely with suppliers, universities, research institutions, certification societies but primarily with our customers, to maintain the most relevant level of expertise in bonding sealing and damping. We are continuously developing the product range as new methods, materials and designs emerge or are needed. All processes concerning application of our products are fully tested and choreographed to ensure 100% reliability.

This manual explains the processes and describes the procedures necessary to achieve the highest standards. It is therefore essential that the appropriate section is consulted and adhered to for every process undertaken.

From long experience in marine applications, it is highly recommended that Sika (Corporate or Local Technical Service) is consulted at the outset of any new projects.





EXPLANATION OF DIFFERENT FIXING METHODS

SOME HISTORICAL FACTS

Traditional fixing methods are mechanical fixations. Adhesives have still the nimbus of a low seriousness due to less and / or negative experiences. Adhesive technologies are not accepted voluntarily. The bonded result cannot visually be detected. The resulting prudence is also called Icarus effect. From this story from the greek mythology only the crash of Ikarus is known where Daidalos his succeeding father is less known. Nevertheless Daidalos, a blacksmith, is the "historical father" of the bonding technology as the wings he produced to escape from his prison have been feathers bonded with an adhesive (light weight construction).

Nowadays aircrafts like the Boeing 787 Dreamliner are made out of synthetic carbon fibres. Only the bonding technology can be used for joining such substrates. The bonding technology is state of the art in multiple areas including the naval industry.

Sealing on the other hand has been one of the oldest technologies in the shipbuilding. Caulking boats with cotton robs impregnated with bitumen is one of the used technologies. Nowadays modern products replace this demanding working procedure.

The differences between some mechanical fixations and the bonding technologies outline some advantages of each method.



Fig. 1 Ikarus and Daidalos. Painting from Carlo Saraceni 1580-162



Fig. 2 Boeing 787 Dreamliner

PRINCIPAL DIFFERENCES OF THE FIXING METHODS

Production	Riveting / screwing	Spot weld	Rigid bonding	Elastic bonding
Process speed	Fast	Fast	Medium to fast	Medium
Substrate preparation	Low	Low	Medium to important	Medium to important
Substrate deformation (heatprocess)	Low	High	Low	None
Tolerance gapping	Low	Low	Low	Very good
Calculation of the bondline	Yes	Yes	Possible	Possible
Industrial hygiene	Low	Low	Medium	Medium
Noise emission during manufacturing	High to low	Medium	Low	Low
Quality control	Easy	Easy	Needs QC	Needs QC
Obtained characteristics	Riveting / screwing	Spot weld	Rigid bonding	Elastic bonding
Joining different materials	Possible / limited	Not possible	Possible	Possible
Sealing	Separate operation	Separate operation	Yes	Very good
Acoustical improvements	No	No	Limited	Yes
Joining of thin substrates	Not recommended	No	Possible	Ideal method
Durability	Danger of corrosion	Danger of corrosion	Good	Good

Adhesive bonding is a modern and highly effective joining technique with a number of innovative performance characteristics, which forms a welcome addition to the standard repertoire of rigid fastening technologies. Through the selective use of these adhesives and careful attention to the specific application techniques associated with them, engineers and designers are now able to design technically sophisticated products that can be manufactured economically.

The use of this bonding technology permits to use all kind of substrates permitting an optimised construction. Just to mention some advantages:

- Freedom of styling (use of GRP / plastics / metals to optimise material cost)
- Weight savings (thinner substrates / plastics)
- Sound reduction (especially with elastic adhesives)
- Corrosion resistance (bonding on anti-corrosive paints, no injury of the anti-corrosive layer)

The highest economic and technical benefit of the bonding technology is based on these multiple advantage which is achieved in a single operation.

The bonding technology is a new tool for engineers and designer to realise modern and innovative solutions in the Marine Industry.



DIFFERENCE BETWEEN RIGID AND ELASTIC ADHESIVES

Elastic adhesives differ in their functionality to the rigid systems. Rigid (high modulus) adhesives are normally used in thin layers of about some hundred microns. In contrast elastic adhesives are used in a thickness of some millimeters. Therefore the expression of thick layer bonding has been created for such application types.

The function of these systems differs in their way to transmit forces. Rigid adhesives transmit forces directly without noticeable deformation. Elastic adhesives lower the forces by bond line deformation and uniform stress distribution over the whole bonding surface.

Both of these systems have their advantages as well as their limitation. The following article describes the principal characteristics, knowing that this classification is not complete as semi flexible products may be situated somewhere in between.

To show the difference, studies have been done at the University of Munich to demonstrate this difference. Tensile lap shear samples of PMMA (Polymethylmetacrylate, ex. Plexiglas) have been bonded and stressed. By using polarized light, lines of different colours (stress levels) could be visualized.



Fig. 3 Test sample. Lap shear test with PMMA substrate bonded with different adhesives. One sample has been screwed

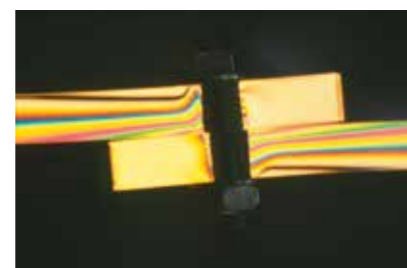

Fig. 4 Screwed sample. The force line indicate a direct transmission of the forces from one part of the sample through the screw to the other part of the sample.



Fig. 5 Same sample plan view. Here stress concentration around the bolts is visible (stress peaks around the screw).

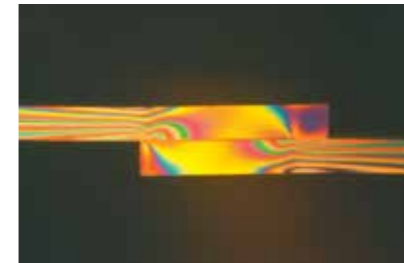

Fig. 6 Thin layer bonded sample with a rigid adhesive. The stress concentration is visible at both ends of the sample.

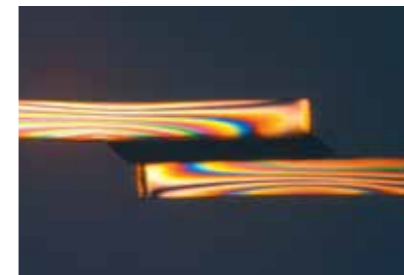

Fig. 7 Thick layer elastic bonded sample. The stress transmission is uniform over the hole bonding area (no stress peaks). The adhesive is not easily visible as it is not transparent.

The uniform stress distribution of the elastic adhesive permits to utilize the whole bonding surface for the force transmission.

Elastic thick layer bonding permits therefore to use thinner substrates, or just to bond directly on painted surfaces for better corrosion resistance, just to mention two of the multiple advantages by using this fixation method.

One of the most contradictory discussion concerns the definition of "Structural bonding" Many authors use this expression in connection with a high strength or modulus of an adhesive. A more practice related definition uses this expression for bonding assemblies which are essential for the functioning to the assembled part. This seems for us a better definition as it will also take in consideration the durability aspects.

Elastic adhesive bonding is a joining technique with a number of innovative performance characteristics, which forms a welcome addition to the standard repertoire of rigid fastening technologies. Through the selective use of these adhesives and attention to the specific application techniques associated with them, engineers and designers are now able to design technically sophisticated products that can be manufactured economically.

Differences between elastic thick layer bonding and rigid thin layer bonding

General Characteristics	Rigid (high modulus) adhesives	Elastic adhesives
Bondline dimension	Thin adhesive layer, small overlapping	Thick layer of at least 2 mm. Higher force transmission may be achieved by increasing the overlap (bonding area)
Temperatur dependency	Glass transition temperature has to be observed. If the bonded object is used over this temperature, mechanical resistance drops and may lead to failures	Elastic adhesives have a glass transition temperature at about minus 50 °C. The dependency of the mechanical strength in the normal application range is minim. However the temperature resistance is limited to approx. 90 °C for elastic Polyurethanes and approx. 120 °C for Silicones
Force transmission	Forces resulted by mechanical stress or differences in thermal expansion coefficient have to be transmitted and result directly from the chosen parameters. In some cases parts may deform during temperature change due to a "Bimetal effect"	Forces applied on an elastic bond line provoke a deformation of the bondline, thus lowering the stress on the substrates
Shock resistance	Normally the shock resistance of a rigid bond line is not very high, especially in the range of the Glass Transition Temperature. However some special formulations have an excellent choc resistance	The shock resistance of elastic bond lines is excellent. The mechanical resistance increases with the applied speed. Under choc resistance, the mechanical resistance is high
Adhesion on painted substrates	The paint adhesion on a substrate is about 7N / mm ² . High modulus adhesive may lead to stress peaks and cause a break between paint and substrate	The modulus of elastic adhesives is lower than the one of the paint. Therefore application on painted substrate is possible. Thereby the corrosion resistance is not impaired
High strength bonding	Good solution. Rigid adhesives may be combined with mechanical fixation methods	Only possible with larger bonding area

Differences elastic thick layer bonding / rigid thin layer bonding

	Rigid thin layer bonding	Elastic thick layer bonding
Bonding of different metals	Perfect in case of metals with low differences in thermal behavior, good for applications where bondline dimension (thickness /surface) is restricted	Good compensation of thermal movements, good protection against galvanic corrosion, good tolerance gapping
Bonding of metals with plastic	Usable for bonding smaller parts, good for applications where bondline dimension (thickness /surface) is restricted.	Ideal for bonding of GRP with important tolerances, good for shock resistance and acoustical damping
Bonding plastic to plastic	Normally good technique with low surface preparation, ideal for sandwich construction with low modulus core materials	Less interesting solution. ESC has to be taken in consideration. Ideal for bonding duromers (glass reinforced plastics) with important tolerances



Fig. 8 Bonded windows on cruise vessel



Fig. 9 GRP parts and windows bonded on high speed ferry



Fig. 10 Luxury megayacht glazing



BONDING CONSTRUCTION DESIGN

PRINCIPALS

Joining of two materials means to connect them to a unit which is capable to transmit forces resulting from dynamic, static or other stress during the use of the subject. Normal joint technologies are mechanical joining methods which are known since long times.

Glues however have been reported to be used about 3000 years before JC. Asphalt and natural resins have been used to tighten up ships and clay has been used to build houses.

However structural bonding started in the 30ties of this century. One of them is unsaturated polyester which are still in use today. The development of epoxy resins opened up a vast area of bonding applications

Elastic adhesives or sealants started in 1964 in the USA using an elastic adhesive for windscreen bonding. This technology is state of the art in all type of windscreen bonding in all market fields.

In the 80ties elastic bonding was used in busses followed by trains and trams in 1992. Structural bonding in Marine started at the beginning of the 90ties. In the meantime, elastic bonding technology was established in other sectors of the manufacturing industry, such as for containers, refrigerators and washing machines, facades, floors, windows and many applications.

The following chapter will help to understand the bonding technology and how to design an adhesive joining case.

Generally forces which in praxis occur are the following:

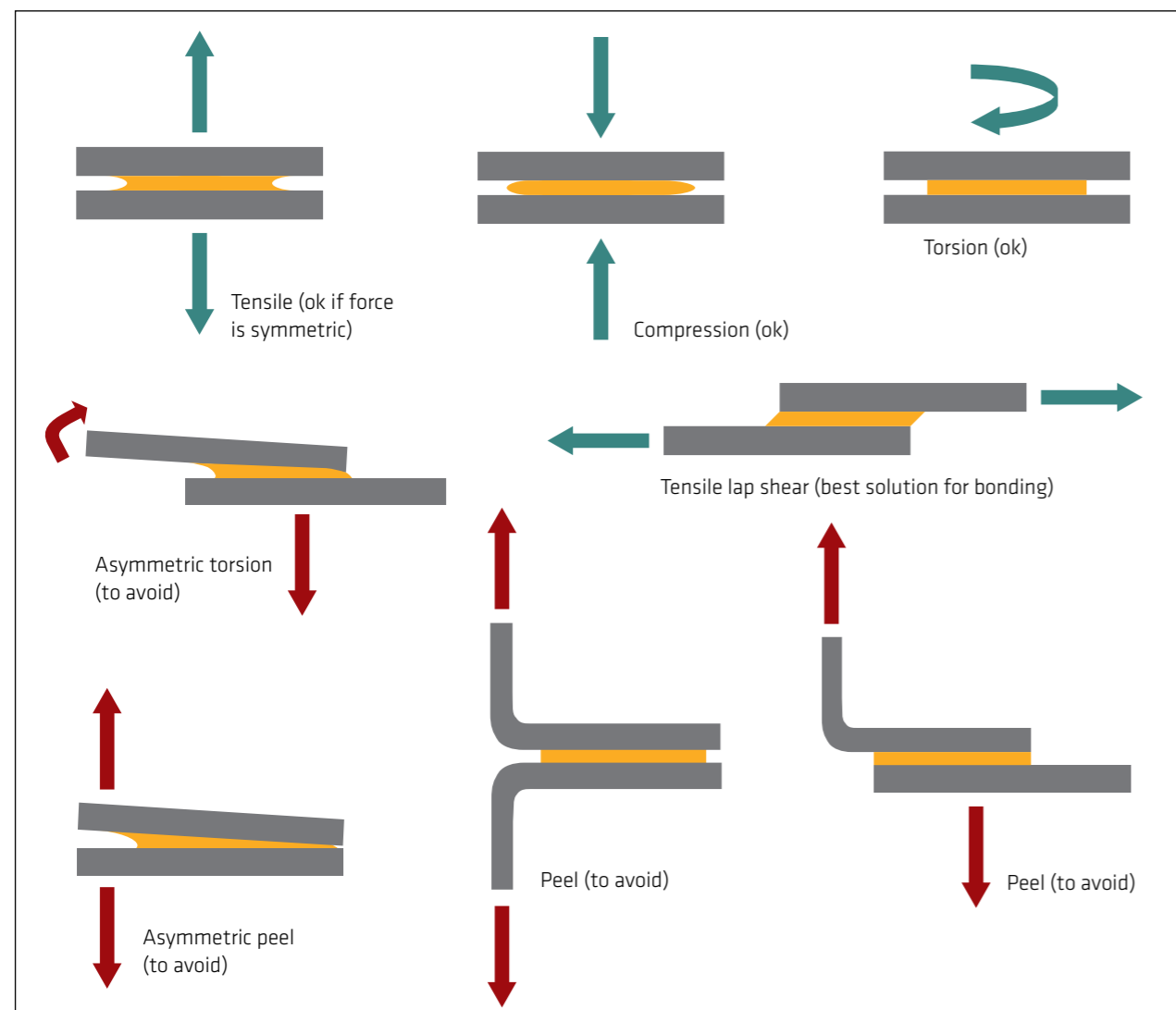

The strength of a joint is basically determined by the area of the bond, the inherent strength of the adhesive or the substrate and the stress distribution within the joint. A poorly designed joint can lead to high stress concentrations in the joint itself and / or in the substrates connected, which in turn can lead to premature failure. Good joint design, which takes into account the practicalities of application as well as the geometry of the joint, is essential for a long service life in a demanding Marine environment.

Peel forces are the most difficult to counter and must be avoided by changing the design of the joint.

Here an example: by changing the construction the risk of peel forces could be minimised

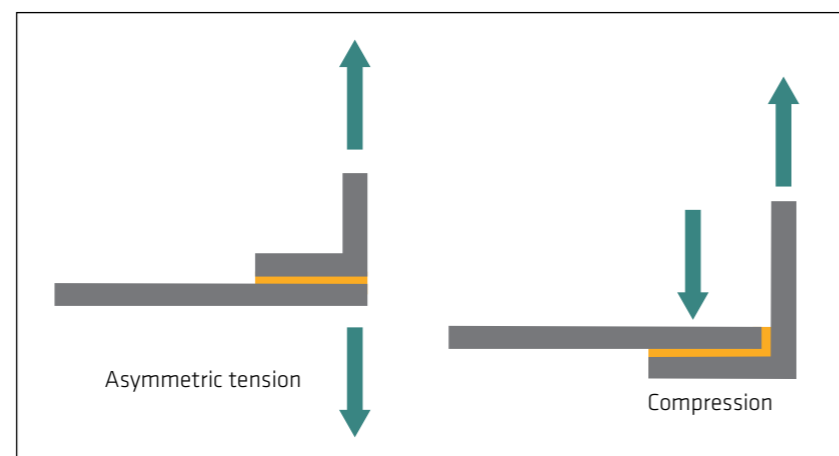

Traditional mechanical joint design has to cope with the inherent strength of an adhesive.

The following examples show some of an adhesive alternative to welding.

CALCULATION OF THE BONDING AREA

The dimensioning of a bond line depends mainly of the forces to be transmitted, and the mechanical resistance of the substrates and adhesives.

One of the most common errors is to calculate the bond line on the bases of the data's in the Product Datasheets. These data's are based on static tests. In praxis a lot of factors have to be considered. Temperature influence, type and frequency of the stress, aging etc. are factors on which the bond line is subjected.

Detailed calculation procedures can be ordered from your local Sika Industry branch or in appropriated literature (Example: "Elastic bonding, the principles of adhesive technology and a guide to its cost effective use in Industry" Verlag Moderne Industrie)

In praxis a rule of thumb can be used as a first approximation. The lap shear strength has to be reduced to 3% of the Product Datasheet value.

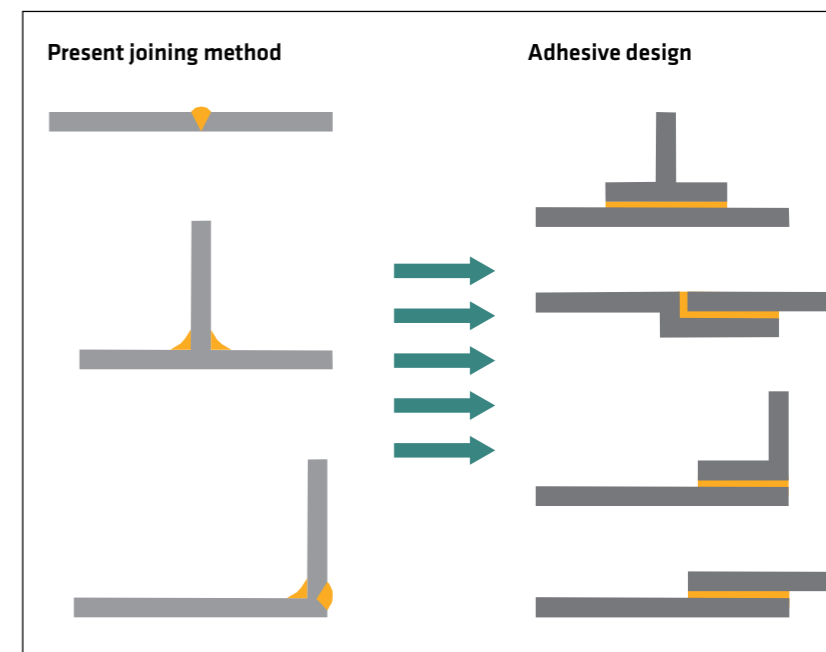

Example:

Tensile lap shear force needed is 200 kg equal to 2000 Newton.
The Product Datasheet value of a particular adhesive is 2 N / mm²

The calculation value for the applicable tensile lap shear strength is only 3% of this Product Datasheet value: 2 N / mm² x 0.03 = 0.06 N / mm²

The required bond surface is therefore: 2000 N / 0.06 N / mm² = 33'000 mm² = 330 cm²

Considering a bond line width of 15 mm, the required length of the joint is:
330 cm² / 1.5 cm = 220 cm or 2.2 m

Note:

For exact calculation with the FEM-Methods we recommend to consult the Technical Service Sika Industry



COST ADVANTAGE OF ELASTIC BONDING

COST COMPENSATION

Adhesives compared to riveting or spot welding result in an advantage of the mechanical fixations.

However, a cost comparison has to be done taking all factors of the realisation in consideration. As an example spot welding may increase the expenditure of the filling of a surface prior to painting, thus increasing the overall costs.

The following list gives thought-provoking impulse to realise a correct cost comparison.

Properties	Benefits (manufacturing)
Bond / seal simultaneously	Reduction of process steps / No additional sealant costs
Compensates for tolerances	Less work to prepare substrate
Application at room temperature (no thermal deformation)	Less spatula work / Low energy costs
Curing at room temperature	Lower energy costs
Bonding different substrates	Optimised choice of materials / lightweight construction / No bimetallic plates necessary
No sink marks on thin sheets	Thinner sheets / savings
Less tools	Lower investment costs

Properties	Benefits (enduser)
Not corrosion-prone fixing	Longer life expectancy
Reduced maintenance	Lower costs
Weight-reduction	Lower fuel consumption
No built-in tensions	Increased longevity
Design with low cw (drag coeff.)	Lower fuel consumption
Application and curing at room temperature	Simple repair
Even surfaces	Easy to clean
Noise reduction	Increased comfort
Freedom of design	Increased brand awareness

TIPS AND TRICKS

SURFACE PREPARATION

GENERAL REMARKS

The surface preparation is beside the material choice and the joint dimensioning the key for a long lasting bond. Therefore it is essential to execute the surface preparation very accurately.

SURFACE CLEANING

Dirty surfaces have to be pre cleaned. For oily or fatty surfaces, steam cleaning with detergents and consecutive rinsing with clean water are recommended for large areas. Smaller areas may be pre cleaned with solvents such as Sika® Remover-208.

Dust on surfaces is best removed with a vacuum cleaner. Compressed air as alternative can be used if it is deoiled.

Rust, other oxides or loose paints have to be eliminated mechanically. Methods are sandblasting, and grinding. In case of sandblasting the type of blasting material has to be chosen according to substrate to clean. If necessary contact an abrasive producer.

Grinding with sand paper may be done with belt grinder, excentric grinder, rotation grinder or manually. The grit to choose depends on the material to eliminate. Usually grit 40-80 is used.

After grinding the dust has to be eliminated with a vacuum cleaner.



Fig. 12 Steam cleaner



Fig. 11 Sandblasting



Fig. 13 Deoiler for compressed air



Fig. 14 Excenter grinder



Fig. 15 Rotative grinder



Fig. 16 Belt grinder

STORAGE OF THE PRODUCTS

STORAGE UNOPENED CARTRIDGE OR UNIPACK

Sikaflex® and Sikasil® products should be stored at a temperature below 25°C. The product shelf life is indicated on each packaging unit.

If the product is stored at higher temperature, viscosity of Sikaflex® rises up to a moment where it is hard to extrude and shows a slight elastic behavior. In this case do not use it as the wetting of the substrate is not ensured anymore.

Sikasil® reacts differently. After the expiry date the reactivity slows down and the physical strength is lower than indicated in the Product Datasheet. The viscosity (extrusion behavior) of the product is not changing.

STORAGE OF AN OPENED CARTRIDGE

If a cartridge is opened and not used for some days, the nozzle has to remain on the cartridge and just changed with a new one before reuse of the cartridge.

If the product will not be used for a longer period, we recommend removing the nozzle and covering the cartridge opening with an aluminum foil. Screw a new nozzle over this foil. When reused after elimination of the foil, the beginning of the extrusion needs a high force. Once the plunger starts to move, the extrusion force drops down to a normal level.

STORAGE OF ACTIVATORS AND PRIMERS

These products should be stored at lower temperatures than 25°C. Once opened bottles should be closed immediately after use. Maximum storage life after opening is 3 months.

PRODUCT APPLICATION

GENERAL ADVICE

Respect the recommendation in the actual Product Safety Sheet concerning collective and personal protection. Use only products within the best before date. Never use thinners or solvents to dilute Activators or Primers.



Fig. 17 Best before date cartridge



Fig. 18 Best before date unipack

APPLICATION OF ACTIVATORS AND PRIMERS

Activators should be applied like a solvent. It is applied on non-porous substrates only! Wet a paper tissue sparingly with the corresponding Activator and wipe the surface in one direction. Turn the tissue to a proper side and continue cleaning. Dry the area with a dry tissue (wipe on /wipe off method) Discard the tissues when dirty according to legal legislation.

Close Activator bottles immediately after use.



Fig. 19 Outer and inner cap



Fig. 20 Close inner cap immediately after use

If you transfer the Activator in a separate can, discard the rest at the end of the day according to legal legislation to prevent inactivation of it.

Do not use an Activator which is cloudy or which show an unusual aspect.

Respect the minimum and maximum waiting time until the adhesive or sealant is applied. Consult the Pre-Treatment Chart Marine.

Primers are applied like paint. Use a clean dry brush, a felt or dauber to apply a Primer.

Sika® MultiPrimer Marine may also be applied with a paper tissue.

Pigmented primer like Sika® Primer-206 G+P or Sika® Primer-209 D have to be shaken until the metal ball in the can be heard. Shake for another minute until the primer is completely homogen.



Fig. 21 Shake



Fig. 22 Outer and inner cap



Fig. 23 Close inner cap immediately after use

If you transfer the primer for use in a separate can, discard the rest of it at the end of the day according to national legislation. With this action inactivation or jellification will be prevented.

Respect the minimum and maximum waiting time until the adhesive or sealant is applied.

APPLICATION OF ADHESIVES AND SEALANTS

The application is done with a good quality type of gun. Cheap guns may fail especially with higher viscous adhesives such as Sikaflex®-292i or -296.

Apply the product with a triangle shaped nozzle of the appropriate dimension, holding the gun in a vertical position.



Fig. 24 Adhesive application

Insert spacers (see page 20) beside the adhesive bead

Join the parts together, applying a uniform pressure until the final position of the parts is reached. Use a flat rod to press flexible parts uniformly to the desired thickness.

In case of vertical application use distance blocks or adhesive tapes to hold the part in position until the adhesive get sufficient strength.

For additional sealing operation, protect the sides with adhesive tapes. Apply the sealant watching a complete filling of the space to prevent air inclusions between adhesive and sealant. Tool the sealant with a flexible spatula. Remove the adhesive tapes as soon as the tooling has been done before skinning of the sealant occurs.

REMOVAL OF ADHESIVES AND SEALANTS

FRESH UNCURED PRODUCTS

On non-porous substrate, remove the sealant or adhesive with a spatula. Clean the left over with a tissue or rag and Sika® Remover-208.

Do not use other solvents as they can react with Sikaflex® forming a permanently sticky surface

On porous substrate it is best to let the product cure and remove it after hardening with mechanical means.

CURED PRODUCT

Cured Sikaflex® can only be eliminated with mechanical means. Solvents do not dissolve the hardened Sikaflex® but may soften it for easier removal (use acetone or isopropyl alcohol)

Note: Never use Sika® Aktivator for cleaning

CLEANING OF HANDS AND SKIN

Contact with Sikaflex® should be avoided. Use personal and collective protection means, such as gloves etc.

Never use solvents to clean the skin. Best is Sika® Handclean towel or other water based cleaning pastes.

Detailed information's about the physiology of the products are available in the national Safety Datasheet, available on the Internet. www.sika.com

AUXILIARY MATERIALS

MASKING TAPE

Masking tapes are to be used to protect the substrate against soiling. Apply the masking tape about 1 mm away from the joint area (see illustration). After application and tooling of the adhesives, the masking tape should be eliminated as soon as possible before skinning of the adhesive or sealant occurs.

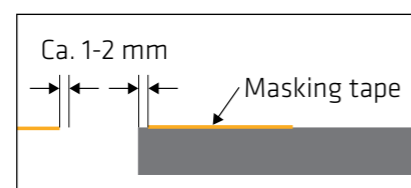

SPACERS

Spacers are used to assure a defined thickness of the bond line. They should be softer (shore hardness) than the cured adhesive.

Suitable materials are self-adhesive bumpers. Other possibility is to produce a small bead or sheet of the Sikaflex® adhesive in the desired thickness. After curing cut it in small parts of approx. 5x10 mm.



Fig. 25 Example of spacers

Fix the spacer on the substrate. If an adhesive is needed we recommend to use a small dot of Sikaflex®. Never use superglue as they exhale vapors which impair a good adhesion of the Sikaflex® adhesive on the substrate.

DISTANCE BLOCKS

Distance blocks are used to temporarily fix vertically bonded parts to prevent sliding.

They are best made of plastics or wood. Never use metals! After sufficient curing of the adhesive. They can be removed to permit the consecutive sealing (backfill) of the remaining joint.



Fig. 26 Distance block

HOW TO AVOID CORROSION

The best corrosion resistance is achieved with suitable paint systems which are designed for the marine conditions.

- Aluminum and ordinary steel have to be protected with such systems. (ISO 12499-3)
- In addition enclosed air pockets or other closed areas (example between adhesive and backfill sealant) have to be avoided. In case of cold application temperature, the viscosity can be decreased warming up the adhesive or sealant in a water bath. (Up to about 40°C)
- Interrupt the bead to allow occasionally entered water (condensed water).

Note: Sika primers give a very limited corrosion resistance and should be used only for adhesion purposes.

PRODUCT SELECTOR, CALCULATION TOOLS

Adhesives / sealants	Sikaflex®-290 DC PRO	Sikaflex®-291i	Sikaflex®-292i	Sikaflex®-295 UV	Sikaflex®-296	Sikaflex®-298	Sikasil® WS-605 S	Sika Firesil® Marine N	Sikasil® N-Plus	SikaTransfloor®-352 ST and SL
APPLICATIONS										
General sealing overpaintable	-	●●●	●●	-	-	-	-	-	-	-
General sealing, weathering resistant	-	-	-	●●●	●●	-	●●●	-	-	-
Fire retardent sealing	-	-	-	-	-	-	-	●●●	-	-
Organic glass bonding	-	-	-	●●●	●	-	-	-	-	-
Mineral glass bonding	-	-	-	-	●●●	-	-	-	-	-
Deck levelling	-	-	-	-	-	-	-	-	-	●●●
Wodden deck bonding	-	●●	-	-	-	●●●	-	-	-	-
Caulking	●●●	-	-	-	-	-	-	-	-	-
Bonding of coverings	-	●●	-	-	-	●●●	-	-	-	-
Sanitary sealing	-	●	-	-	-	-	-	-	●●●	-

SERVICE CONDITIONS

High temperature > -40 °C to 150 °C	-	-	-	-	-	-	-	●●●	●●	-
Normal temperature -40 °C to 90 °C	-	●●●	●●●	●●●	●●●	●●●	●●●	-	-	●●●

See also Pre-Treatment Chart for Marine Applications

KEY TO SYMBOLS

●●●	Best solution
●●	Good solution
●	Possible solution

ADHESIVE PRIMER CONSUMPTION

DESIGN OF ADHESIVE LAYER GEOMETRY

The elastic adhesive can only fully develop its positive properties (movement compensation, peeling and impact resistance) if the adhesive layer geometry is correct.

Above all, this means keeping to a minimum layer thickness that must be individually suited to the bond. A layer thickness of 2-3 mm has proved best for most applications. Thicker layers may be required where considerable movement is expected.

Depths over 20 mm should be avoided with standard Sikaflex® grades because the adhesive would take too long to harden.

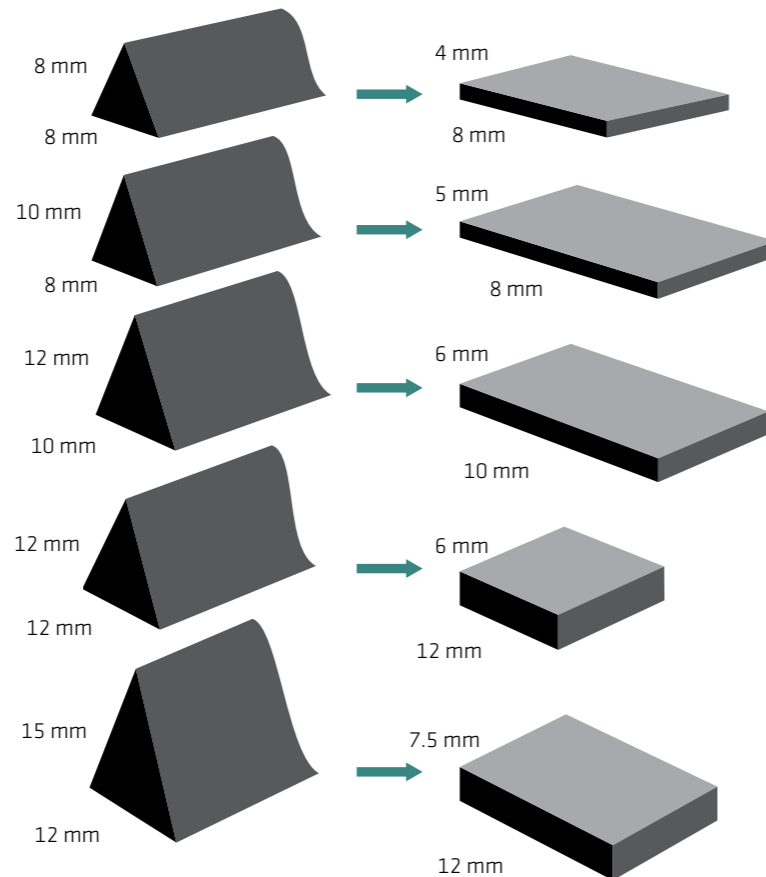

JOINT WIDTH	NO. OF METRES PER 300 ML CARTRIDGE			NO. OF METRES PER 100 ML TUBE		
	5	10	15	5	10	15
1	62.00	31.00	20.60	20.00	10.00	6.60
2	31.00	15.50	10.30	10.00	5.00	3.30
3	20.60	10.30	6.88	6.60	3.30	2.20
4	15.50	7.75	5.15	5.00	2.50	1.60
5	12.40	6.20	4.10	4.00	2.00	1.30
6	10.30	5.16	3.44	3.30	1.60	1.10
7	8.85	4.40	2.95	2.80	1.40	0.90
8	7.75	3.90	2.60	2.50	1.20	0.80
9	6.90	3.50	2.30	2.20	1.10	0.70
10	6.20	3.10	2.00	2.00	1.00	0.60

PRIMER AND CLEANER CONSUMPTION

PRODUCT	YIELD PER 100 ML AT 20 MM WIDTH (m)	BRUSH APPLICATION TISSUE APPLICATION* (l / m ²)
Sika® Aktivator / Sika® Aktivator-205	25-30	0.04*
Sika® Primer-206 G+P	17-22	0.1-0.15
Sika® Primer-209 D	12-15	0.15-0.2
Sika® MultiPrimer Marine	12-15	0.15-0.2

Make sure that:

- The primed areas coincide with the bonding areas
- The right primer for the material surface is used
- The primer is completely dry and cured before bonding i.e. watch the evaporation time
- Primers are shaken if necessary

CONVERSIONS AND CALCULATIONS

FORMULAE

TO ESTIMATE THE NUMBER OF LITRES REQUIRED

Normal bead application;
 Quantity in litres = $\frac{\text{bead width (mm)} \times \text{bead thickness (mm)} \times \text{joint length (metres)}}{1000}$
 (Dimensions are for wet adhesive in rectangular cross section)

Large area bonding and laminating;
 Quantity in litres = width (metres) x length (metres) x wet film adhesive thickness (mm).

TO DETERMINE THE VOLUME OF A SEMI-CIRCULAR BEAD

Quantity in litres = $\frac{3.142 \times \text{diameter (mm)} \times \text{diameter (mm)} \times \text{length (metres)}}{8000}$

TO DETERMINE THE VOLUME OF A TRIANGULAR BEAD

Quantity in litres = $\frac{\text{width (mm)} \times \text{height (mm)} \times \text{length (metres)}}{2000}$

TO CONVERT KILOGRAMS TO LITRES

Quantity in litres = $\frac{\text{weight in kilograms}}{\text{density (grams / ml or kg / l)}}$

TO CONVERT BETWEEN TEMPERATURE SCALES

Fahrenheit = $\frac{(\text{degrees celsius (°C)} \times 5)}{9} - 32$

Celsius = $\frac{(\text{degrees fahrenheit (°F)} \times 9)}{5} + 32$

WEIGHT	
1 ounce =	28.3495 g
1 pound =	0.45359 kg
1 hundredweight =	50.8023 kg

AREA	
1 inch ² =	645.16 mm ²
1 foot ² =	0.0929 m ²
1 yard ² =	0.8361 m ²
1 acre =	4046.86 m ²
1 mile ² =	2.59 km ²

VOLUME	
1 pint (UK) =	0.5683 l
1 pint (USA) =	0.4732 l
1 gallon (UK) =	4.5461 l
1 gallon (USA) =	3.7854 l

LENGTH	
1 inch =	25.4 mm
1 foot =	0.3048 m
1 yard =	0.9144 m
1 furlong =	201.17 m
1 mile =	1.6093 km

PRESSURE	
1 bar =	0.1 MPa
1 Pascal =	1 N / m ²
1 kgf / cm ² =	0.09807 MPa
1 psi =	6894.76 Pa

SI PREFIXES		
NAME	SYMBOL	FACTOR
giga	G	10 ⁹
mega	M	10 ⁶
kilo	k	10 ³
hecto	h	10 ²
deca	da	10 ¹
deci	d	10 ⁻¹
centi	c	10 ⁻²
milli	m	10 ⁻³
micro	μ	10 ⁻⁶
nano	n	10 ⁻⁹

The information, and, in particular, the recommendations relating to the application and end-use of Sika products, are given in good faith based on Sika's current knowledge and experience of the products when properly stored, handled and applied under normal conditions. In practice, the differences in materials, substrates and actual site conditions are such that no warranty in respect of merchantability or of fitness for a particular purpose, nor any liability arising out of any legal relationship whatsoever, can be inferred either from this information, or from any written recommendations, or from any other advice offered.

The proprietary rights of third parties must be observed. All orders are accepted subject to our current terms of sale and delivery. Users should always refer to the most recent issue of the Sika Product Datasheet for the product concerned, copies of which will be supplied on request.

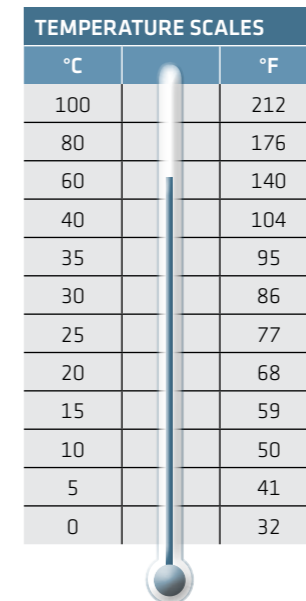



QUALITY ASSURANCE

PRACTICAL HINTS

This chapter examines the practical issues of quality assurance for elastic adhesive and sealant applications

The proposals outlined here should be viewed as a general checklist to be adapted to the specific requirements of each marine manufacturing environment.

Particular attention needs to be paid to establishing an effective system of quality assurance for adhesive connections.

Testing of the adhesion, and therefore the reliability, is only possible by destructive means.

Visible inspection is only effective to a limited degree, so the quality of the bond line has to be assured by the following:

- Ensure the constance of the surface quality of the substrates to be bonded
- Correctly prepare the surfaces to be bonded
- Select the correct adhesive (as specified by the manufacturer)
- Apply (and cure) the adhesives correctly
- Respect engineering rules such as joint dimensions, etc.

If these parameters are maintained within the prescribed limits, then the quality, strength and durability of the adhesive bond is ensured.

In addition, there is little or no need to supplement these measures with time-consuming and costly destructive testing.

The following table (Quality Assurance Programme) shows that quality assurance begins at the project stage and continues throughout construction, right up to the final rollout of the product. It outlines a typical quality management programme for adhesive applications. This model has been adopted with very satisfactory results in many areas of OEM ship building and in the subcontractor segment of the marine industry.

QUALITY ASSURANCE PROGRAMME

PROJECT STUDY	CONSTRUCTION OF PROTOTYPE	END OF TEST PHASE	SERIAL PRODUCTION
Design and construction adapted to adhesive technology and assembly methods	Checking and specifying correct method of substrate preparation in consultation with adhesive and paint suppliers	Evaluation of test phase, making any design changes that may be indicated	Implementation of a quality assurance system
Dimensioning and configuration of adhesive joints based on existing codes of practice and design data	Construction of prototype based on design criteria for adhesive bonding. Adhesive supplier (applications engineer) to advise where necessary	Preparation of a production and quality assurance manual for adhesive bonding applications, taking into account the key application parameters of temperature and humidity	Periodic refresher courses and further training for personnel
Appointment of an in-house adhesives specialist to liaise between departments on all aspects of adhesive usage	Specifying type and scope of repair works	Training of assembly personnel in the use of adhesives	Introduction of activities aimed at raising quality standards (e.g. quality awareness groups)

In commercial enterprises that use adhesives in serial production, the sound working knowledge of adhesive technology needed is generally confined to a few individuals in technical departments. The policy of training one technician as an in-house adhesives specialist has proven

to be an effective solution to making this information available on the production floor. The trained person is also able to coordinate all aspects of adhesive usage for marine projects as a whole and acts

as a neutral adviser to the individual departments concerned.

The following table highlights the main issues that need to be addressed.

MAIN POINTS OF CONSIDERATION FOR THE INTRODUCTION OF ADHESIVE TECHNOLOGY

ADHESIVE	Selected to suit the requirements of the production cycle and the service stresses to which the finished assembly will be subjected
SUBSTRATE	Consistent and sound composition and surface condition
SURFACE PREPARATION	Selected to suit the requirements of the production cycle and the service stresses to which the finished assembly will be subjected and to accommodate variances in unstable substrates (mould release in GRP, wood)
APPLICATION PARAMETERS	Working within the specified time limits (open time), taking account of temperature and relative humidity levels
JOINT DESIGN	Adhesive-friendly joint design, dimensioning of joints to suit functional requirements of finished assembly in accordance with manufacturers engineering rules. Think about a possible repair solution
STAFF TRAINING	External or internal training courses organized in conjunction with adhesive suppliers

The following table is a guide to the preparation of a quality assurance concept. The scope and frequency of the test regime will need to be adjusted to the scale of the project and to the availability of technical and manpower resources.

A GUIDE TO THE PREPARATION OF A QUALITY ASSURANCE CONCEPT

AREA OF RESPONSIBILITY	CHECKS AND CONTROLS	DEPARTMENT / PERSON RESPONSIBLE
ENSURING CONSISTENT QUALITY OF SUBSTRATE	Specification (name, brand, grade, supplier, chemical composition, manufacturing processes, details on mould release systems used, etc.) Release system (open mould, infusion)	Design and engineering
	Contractual agreements specifying quality and condition of substrate (duty to inform in event of changes)	Purchasing
	Checks on incoming deliveries (name, brand, grade, product characteristics) with adhesion tests (see Pre-Treatment Chart)	Quality assurance
	Correct storage (temperature, humidity, prevention of soiling, first-in first-out stock rotation)	Quality assurance / Logistics
PREPARATION OF SUBSTRATE	Specification (mechanical surface preparation, chemical products, type of application, processing schedule)	Design and engineering / Adhesives technician / Adhesive supplier
	Checks on incoming deliveries (name, brand, grade, visual inspection of packaging, labelling, product characteristics)	Quality assurance
	Correct storage (temperature, humidity, prevention of soiling, use of stock by expiry date)	Quality assurance / Logistics
	Subjective checks for visible defects in primers, etc. (E.g. cloudiness, sedimentation, thickening, smell), plus checks on expiry date	Quality assurance / Foreman
	Periodic checks on the correct application procedures (method of application, observation of recommended drying times, correct handling of primed components prior to assembly, etc.)	Quality assurance / Adhesive technician / Adhesive specialist
APPLICATION OF ADHESIVE	Checks on incoming deliveries (name, brand, grade product characteristics, visual inspection of packaging, labelling, periodic adhesion tests ¹⁾)	Quality assurance
	Correct storage (temperature, humidity, conditioning of stock to room temperature, use of stock by expiry date)	Quality assurance / Logistics
	Subjective checks for visible defects in adhesives (changes in consistency, flow behaviour, etc.), plus checks on expiry date	Quality assurance / Foreman
	Periodic checks on correct application procedures (method of application, observance of specified open times, correct joint assembly sequence, waiting times prior to further processing, etc.)	Quality assurance / Adhesive technician / Adhesive specialist

¹⁾ Adhesion tests are based on DIN 54457

Nowadays, bonding technology is a well accepted and proven practical assembly method. However if the correct application procedures are neglected, the bonded or sealed object will not comply with expectations. In fact the correct use of adhesives and sealants in marine applications should not be regarded any

differently from other traditional industrial skills such as welding or painting. The only real difference is that applications use a wide range of different materials and subsequently this requires personnel with specialist skills and training.

This manual supplies all of the information necessary for the correct application of adhesives and sealants. However, should there be any doubt regarding materials, methods or applications, support and advice can be obtained from the Marine expert at the nearest Sika Industry organisation.



PRODUCT DATASHEETS AND SAFETY DATASHEETS

PRODUCT DATASHEETS (PDS)

The Product Datasheet describes the product characteristics as well as information about the area of application, advantages and application descriptions.

Before using Sikaflex® or other Marine products we recommend to download the actual Product Datasheets from the Internet.

As the legal part depends on the country of application, the Product Datasheet has to be downloaded from the national internet site. Choose worldwide and click on the respective country.

SAFETY DATASHEETS (SDS)

The Safety Datasheet helps to work safely with chemical products. This document has to be available to everyone which is in direct and indirect contact with chemical products.

- The content of the SDS
- Identification
- Composition
- Hazards
- First-aid measures
- Fire-fighting measures
- Accidental release measures
- Handling and storage
- Exposure controls
- Personal protection
- Physical / chemical properties
- Stability and reactivity
- Toxicological information
- Ecological information
- Disposal considerations
- Transport regulatory information

Most up-to-date Safety Datasheet are available through the local sales organisation, or on www.sika.com.

DISCLAIMER

The information, and, in particular, the recommendations relating to the application and end-use of Sika products, are given in good faith based on Sika's current knowledge and experience of the products when properly stored, handled and applied under normal conditions. In practice, the differences in materials, substrates and actual site conditions are such that no warranty in respect of merchantability or of fitness for a particular purpose, nor any liability arising out of any legal relationship whatsoever, can be inferred either from this information, or from any written recommendations, or from any other advice offered. The proprietary rights of third parties must be observed. All orders are accepted subject to our current terms of sale and delivery. Users should always refer to the most recent issue of the Sika Product Datasheet for the product concerned, copies of which will be supplied on request.



SIKA MARINE APPLICATION GUIDE TEAK DECKING

CONTENT

30 General Description

31 Types of Teak Deck

31 Joint Dimensioning

33 Procedure of Levelling, Bonding and Caulking of Teak Decks

38 Prefabricated Teak Decks

41 Maintenance of Teak Decks

42 Teak Deck Repair

47 Alternatives to Teak

50 Bonding of Timber Elements



DECK COVERINGS

GENERAL DESCRIPTION

Deck coverings are of functional and esthetical importance. Since maritime conditions are harsh, the ship has to be produced not only with the best products but also in accordance with a professional workmanship.

This manual will help to produce durable bonding and sealing solutions. For project related informations we recommend to consult the corresponding national Technical Service.

TEAK DECK HISTORY

Teak has been used for hundreds of years as a durable deck material.

The hard wood is very durable. Natural antimicrobial and insecticide substances cause an excellent natural anti-rot and weathering resistance.

Alternatives for teak such as iroko, padouk etc. are used in some cases but needs an intensive protection work to assure a long time function. Usually they are used in workboats as thick protective floors.

Regardless of the type of wood used, all require sealants to protect the deck from water penetration that can cause severe damage. This can take the form of unsightly marks along the hull, rotting the woodwork and corroding metal components.

Watertight seals are therefore absolutely essential. Also, in addition to adding structural strength to the subdeck, a wooden deck contributes to the insulation in hot and cool climates alike.

Teak, however, is not a uniform material. Oil, fat, talc and resin-content, as well as porosity and colouration, differ depending on the source and age of the wood.

The following pages detail the correct procedures for the planning, laying, preparing and caulking of teak decks with Sika's Totally Glued Teak Decking System.

TYPES OF TEAK DECK

The Teak planks vary in dimension. The later have been used for luxury vessel decking's with mechanical fixation. Up to now the 22 mm planks applied with the Sikaflex® bonding technology result in the same durability at a more economic price.

The joint for caulking is realised in two ways:

1. SYMETRIC OR ASYMETRIC JOINTS

Advantages:

- Simple manufacturing process

Disadvantages:

- Limited joint depth for restoration or refurbishment grindings
- Higher risk of water penetration between planks and the deck (detachment due to wood swelling)

IMPORTANT:
A bond breaker tape on the bottom of the joint to prevent 3-side adhesion is not necessary.



2. DEEP JOINT METHOD

Advantages:

- High grinding (removal) reserve
- Cost saving by using thinner wood planks
- Better adsorption of wood expansion

Disadvantages:

- More complicated working procedure for curved planks

IMPORTANT:
We generally recommend to use the deep joint method whenever possible.



JOINT DIMENSIONING

The joint width depends on the width of the plank, the humidity of the wood when manufactured and the expected humidity in use of the ship.

IMPORTANT:
The change of wood humidity is under normal conditions (wood humidity max. 12%) in the range of 5% to 6%.

GENERAL RECOMANDATION FOR JOINT WIDTH (TEAK)

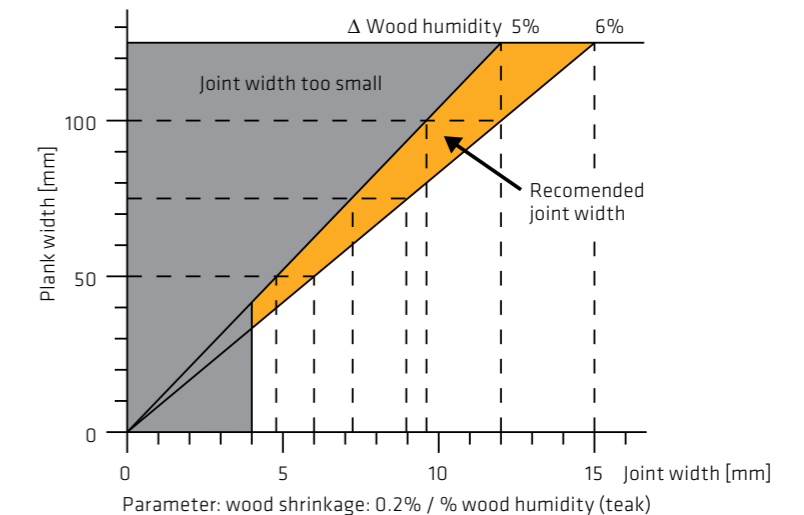

The humidity of the wood can be measured or estimated from the following graph:

WOOD HUMIDITY (% BY WEIGHT)

Relative humidity	Tempera- ture	10°	15°	20°	25°	30°	35°	40°
	90 %		21.1	21.0	21.0	20.8	20.0	19.8
85 %		18.1	18.0	18.0	17.9	17.5	17.1	16.9
80 %		16.2	16.0	16.0	15.8	15.5	15.1	14.9
75 %		14.7	14.5	14.3	14.0	13.9	13.5	13.2
70 %		13.2	13.1	13.0	12.8	12.4	12.1	11.8
65 %		12.0	12.0	11.8	11.5	11.2	11.0	10.7
60 %		11.0	10.9	10.8	10.5	10.3	10.0	9.7
55 %		10.1	10.0	9.9	9.7	9.4	9.1	8.8
50 %		9.4	9.2	9.0	8.9	8.6	8.4	8.0
45 %		8.6	8.4	8.3	8.1	7.9	7.5	7.1
40 %		7.8	7.7	7.3	7.3	7.0	6.6	6.3
35 %		7.0	6.9	6.7	6.4	6.2	5.8	5.5
30 %		6.2	6.1	5.9	5.6	5.3	5.0	4.7
25 %		5.4	5.3	5.0	4.8	4.5	4.2	3.8

Source: R. Kaylwert und Angaben des U.S. Forest Products Laboratory, Madison 1951

CALCULATION EXAMPLE:

Plank width: 50 mm

Production condition: wood humidity measured: 7%

Expected climatic conditions in use: 30 °C / 70 % r.h

Corresponding wood humidity (see table): 12.4%

Maximal change in wood humidity: 12.4% - 7% = 5.4%

Maximal plank movement (teak) 5.4% x 0.2% / % wood humidity change x 50 mm = 0.54 mm

Practical excepted joint movement: 10% of the joint width

Calculated joint width: 0.54 mm x 10 = 5.4 mm (practical 6 mm)

IMPORTANT:
The minimal joint width is in any case 4 mm. Adjacent joints to walls and profiles should be doubled in size.

PRECONDITIONS OF TEAK BONDING

The teak quality is essential for an optimal result in respect of functionality and optical aspect.

Standing year rings as well as the absence of alternating spiral growth are essential to assure a uniform plank deformation under the different climates. Laying year rings may in addition lead to a danger of foot injuries due to scale of wood formation.



Fig. 27 Left side: laying year rings are not recommended. Right side: standing year rings are best.



PROCEDURE OF LEVELLING, BONDING AND CAULKING OF TEAK DECKS

GENERAL WORKING CONDITIONS

The preferred working conditions for applying sealant to decking are as follows:

- Outside temperature 5 °C to 35 °C and maximal 75 % relative humidity
- Avoid increasing temperature during the first day
- Avoid exposure to direct sunlight and rain
- Prevent exposure to the elements for a minimum of 8 hours after the last step of the process
- Ensure adequate ventilation if necessary
- Avoid dirt, dust, oil, fat, grease, water during all processes as these can cause adhesion failure

SURFACE PREPARATION AND PRIMER APPLICATION

Timber decks are usually applied on top of a sub deck of steel, aluminum, polyester GRP or wood. Aluminum and steel decks may be deformed by the welding process and require a levelling process whereas wooden and polyester GRP decks are normally even by nature.



Fig. 28 Typical welds and weld splatter of a steel deck

ALUMINUM OR STEEL DECKS

Steel: the surface must be grinded or sand-blasted to remove rust, loose particles, flaked paint, contaminants, etc.

When complete, remove all dust with a vacuum cleaner

Aluminum: This surface should be slightly sweep-blasted or sanded

Treat the surface with Sika® Aktivator-205 using a clean, lint free rag or a paper towel. Change the rag frequently

Flash off: 10 minutes (min) to 2 hours (max)

Take care to avoid dust, dirt or other contaminates until the next step has been carried out

Check the air humidity and temperature and apply the product only if the surface temperature is higher than indicated in table on page 35 (Minimal substrate temperature to avoid water condensation). Respect the lower temperature limit.

Surface and air temperature has to be between 10 °C and 35 °C.

Mix the two parts of SikaCor® ZP Primer for 3 minutes, using an electric paddle mixer. Scrape the sides and the bottom of the container and mix for another 30 seconds. Do not split pre-packed cans. Use full kits only.

Always monitor the pot life (1 hour at 30 °C, 3 hours at 10 °C).

Apply SikaCor® ZP Primer with a short hair roller. SikaCor® ZP Primer consumption, approx 200g / m².

Drying time before next application:
10 °C: 5 to 14 hours
20 °C: 3 to 14 hours
30 °C: 2 to 14 hours

Protect the area until SikaCor® ZP Primer has hardened.

If the area is contaminated, vacuum clean again and then treat thoroughly using Sika® Aktivator-205.

If drying time exceeds the maximum 3 days flash of time, abrade the surface with a rotating sanding machine using P36 grit and vacuum clean thoroughly. Then reapply the SikaCor® ZP Primer.

GLASS FIBRE REINFORCED PLASTIC DECKS

Heavily soiled surfaces should be cleaned off first with a pure solvent (Sika® Remover-208) to remove the worst of the soiling

Lightly abrade the contact area with a sanding pad

Remove the dust with a vacuum cleaner

Treat the substrate with Sika® Aktivator-205, using a clean, lint-free rag or a paper towel. Change the rag frequently!

Flash off time: 10 minutes (min) to 2 hours (max)

Apply a thin coat of Sika® MultiPrimer Marine using a clean brush, a foam pad or a felt applicator

Flash off time: 30 minutes (min) to 24 hours (max)



Fig. 29 Applying SikaCor® ZP Primer with a roller

DECK LEVELLING

Steel and aluminum decks are usually deformed by the welding process. They need to be levelled before applications of the teak panels. Levelling is carried out using SikaTransfloor®-352 SL (self levelling) or SikaTransfloor®-352 ST (slight thixotropic). SikaTransfloor®-352 SL should be used on even decks SikaTransfloor®-352 ST is more thixotropic and can be used for decks with a sheer of 3 degrees.

SikaTransfloor®-352 SL and SikaTransfloor®-352 ST show excellent adhesion to the SikaCor® ZP Primer. It represents a lightweight two-component polyurethane based system that cures to a smooth and efficient sound damping layer.

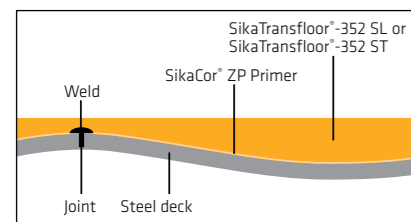

Fig. 30 Cross-sectional detail of deck showing levelling of high spots (weld) and uneven surface

IMPORTANT: Condensation or water droplets on the levelled deck will cause adhesion failure; always monitor the dew point.

APPLICATION TEMPERATURE

The temperature (substrate / product / air) should be between 10 °C to 35 °C

In case of unfavourable climatic conditions, humidity in the air may condensate on a colder surface. Therefore the substrate temperature has to be controlled and should be equal or higher than indicated in the following graph (see page 35).

THE DECK LEVELLING PROCESS

	Stir component A and add component B of SikaTransfloor®-352 SL or SikaTransfloor®-352 ST.	
	Mechanically mix for three minutes at a medium speed. Avoid air entrapment.	
	Immediately transfer the entire contents of the SikaTransfloor®-352 (SL/ST) mixture to another container, scraping the sides and bottom. Mix the new container for another minute before transferring the mixture onto the deck. Never scrape the remaining contents out of a pail onto the deck as this may not be completely mixed. Instead transfer any remnants to the next pail in the process and mix in with a new quantity. Repeat this as many times as required	
	Pour the SikaTransfloor®-352 (SL/ST) mixture onto the area to be applied. Always observe the working time restrictions: 45 minutes at 10 °C, 35 minutes at 20 °C and 25 minutes at 30 °C	
	Spread the mixed SikaTransfloor®-352 (SL/ST) onto the deck using a bar or straight edge at a thickness just exceeding the highest elevation point of the steel or aluminium deck. Do not apply at a thickness over 30 mm. If this should be necessary, the operation must be carried out in several consecutive processes with intermediate sanding of the cured SikaTransfloor®-352 (SL/ST) surface followed by vacuum cleaning. Working conditions: 10 °C to 35 °C and 80 % r.h. max.	
	Drying time: The SikaTransfloor®-352 (SL/ST) coating can be walked over after 24 hours and is ready for the next stage in the process	

Fig. 31 Mixing SikaTransfloor®-352

Fig. 32 Transferring the SikaTransfloor®-352 (SL/ST) to another container

Fig. 33 Pouring the SikaTransfloor®-352 (SL/ST) to the floor

Fig. 34 Spreading the SikaTransfloor®-352 (SL/ST)



DECK BONDING AND BEDDING

Application on levelled surface with SikaTransfloor®-352 SL or SikaTransfloor®-352 ST.

Proceed with sanding the surface of cured SikaTransfloor®-352 (SL/ST) prior to application of the bonding / bedding compound Sikaflex®-298 or Sikaflex®-298 FC. In the time between the curing of the levelling compound and applying the bedding compound, the surface of the SikaTransfloor®-352 (SL/ST) must be kept free of soiling from footprints, dirt, dust, grease, fat, oil and other contaminants. The sanding process should be carried out using appropriate belt-sanding equipment with an 80 grit paper and followed by a thorough vacuum cleaning.

APPLICATION ON OTHER SUBSTRATES

If levelling with SikaTransfloor®-352 (SL/ST) is not required, planks should be offered up and their positions should be marked. When all have been marked, the planks should be removed ready for the primer.

	For all woods: Apply a thin continuous coat of Sika® Primer-290 DC or Sika® MultiPrimer Marine using a roller or spray equipment
	Flash off times: 30 min to 24 hours

Ideally the surface as well as the joint is primed if the planks are embedded and the sealing of the joint is executed in a short time period.



Fig. 35 Applying Sika® Primer-290 DC or Sika® MultiPrimer Marine to a teak deck with a roller (hidden side)

Application temperature	10 °C (50 °F)	20 °C (68 °F)	30 °C (86 °F)
Pot life SikaCore® ZP Primer	3 h	2 h	1 h
Waiting time before application of SikaTransfloor®-352 ST or SL	5 h - 14 h	3 h - 14 h	2 h - 14 h
Working time SikaTransfloor®-352 ST and -352 SL	45 min approx.	35 min approx.	25 min approx.
Waiting time before installation of timber decking with Sikaflex®-298	up to 14 days	up to 14 days	up to 14 days

Working / waiting / drying time for SikaCore® ZP Primer, SikaTransfloor®-352 (SL/ST)

MINIMAL SUBSTRATE TEMPERATURE TO AVOID WATER CONDENSATION ON THE SURFACE¹⁾

Air humidity		< 50 %	50 %	60 %	70 %	80 %	90 %
Air temperature	5 °C	0	0	0	3	5	7
	10 °C	3	3	6	8	10	11
	15 °C	8	8	10	13	15	16
	20 °C	12	12	15	17	19	21
	25 °C	17	17	20	22	24	26
	30 °C	21	21	24	27	29	31

¹⁾ calculated by the dew point plus 3 °C security

gray = not allowed condition
yellow = allowed condition

Example air temperature 10 °C / relative humidity 60 % result: minimal surface temperature: 6 °C : conclusion: not allowed working conditions (minimal 10 °C).

APPLICATION OF Sikaflex®-298 AND EMBEDDING OF THE PLANKS

Sikaflex®-298 or Sikaflex®-298 FC is a low viscous, exceptionally strong flexible one-component adhesive which is applied with a 4 mm comb trowel. The consumption should be around 1.2 liters (2x 600 ml sausages) per m². The quantity has to be adjusted according to the surface texture. In any case the planks have to be embedded totally without any air pockets between substrate and planks.



Fig. 36 Carefully applying Sika® Primer-290 DC or Sika® MultiPrimer Marine



Fig. 37 Hand application picture comb trowel and comb trowel detail

IMPORTANT: Only cover an area that will allow adequate time for a manageable quantity of deck planking to be placed before a skin forms on the adhesive (see Product Data-sheet).

Hold the planks in place by mechanical means such as weights / sandbags or by vacuum pressing.

The fixation may be released after 24 hours. If a shorter waiting time is needed or in case of low temperature / humidity we recommend spraying sparingly a mist of water over the surface just before placing the planks. The needed water quantity is only about 1 gram water per square meter of Sikaflex®-298.

In such a case the fixation time is reduced to some hours.

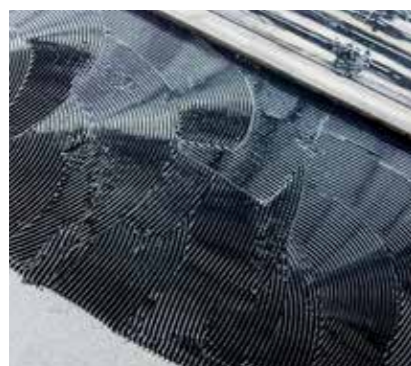

Fig. 38 Sikaflex®-298 applied with a comb spreader



Fig. 40 A teak floor being laid, showing the bedding compound and the weights to hold it in place



Fig. 39 Putting down the decking



Fig. 41 Vacuum press







Fig. 42 Vacuum equipment

DECK CAULKING WITH Sikaflex®-290 DC PRO

As soon as the teak planks are fixed, the caulking may be done.

PRIMING THE SUBSTRATE SEAMS

Priming of the planks is an absolutely vital step in the process of caulking with Sikaflex®-290 DC PRO.







-  If the planks are not already primed, this operation has to be done using a brush in a smaller size than the joint width
-  In order to achieve long-term adhesion of Sikaflex®-290 DC PRO to the sides of the joints, meticulous preparation of the seams is required. Remove all dirt with a vacuum cleaner.
-  **Primer** Apply a thin coat of Sika® Primer-290 DC or Sika® MultiPrimer Marine to the edges of the joint seams. It can be applied by brush or spray in one coating operation. Application temperature: 10 °C to 35 °C
-  **Drying time:** 10 °C to 35 °C: 30 min to 24 hours

! IMPORTANT: If the caulking process is followed not later than one day after the bedding, priming can be done simultaneous for both working steps (plank priming including seams). Take care to avoid soiling of the teak before caulking has been done



Fig. 43 Applying Sikaflex®-290 DC PRO

APPLICATION OF Sikaflex®-290 DC PRO DECK CAULKING COMPOUND

-  Before any work commences, ensure that the temperature of the wood does not exceed 35 °C
-  In addition, the ambient temperature during application should be constant or falling and ideally within the range of 5 °C and 35 °C
-  **290 DC PRO** Apply Sikaflex®-290 DC PRO ensuring that air is prevented from entering the seam by placing the tip of the nozzle against the bottom of the joint and keeping the gun at an angle of about 60°. If narrow joints need to be caulked a specially designed nozzle may be required. Use a handgun, a piston-driven airgun or a battery operated gun. Continue to apply along the seam so that the joint appears to slightly overfill behind the nozzle, but maintain a constant motion
-  After applying Sikaflex®-290 DC PRO but before skinning occurs, compress the excess material onto the surface of the deck using a slightly flexible spatula at an angle of 60°. This produces a convex appearance of the joint and fills the seam completely (see Fig. 45)
-  Protect the joints from rain and direct sunlight prior, during and after caulking, for a period of at least eight hours. Do not use excess material from the spatula to prevent bubbles in the joint
-  Sikaflex®-290 DC PRO is ready for sanding following the conditions outlined on the bar chart in Fig. 44

Relative air humidity	Air Temperature (°C)		
	10 °C	20 °C	30 °C
25 %	5.5 days	4.5 days	3.5 days
50 %	4 days	3.5 days	3 days
75 %	4 days	3 days	2 days

Fig. 44 Safe sanding time



Fig. 45 Compressing Sikaflex®-290 DC PRO with a spatula

DECK SANDING

For efficient sanding results, use an industrial sander. It is recommended to begin with a medium paper at about 80 grit, progressing up to 120 grit. Suitable sanders are belt sanders, flat plate, or elastically suspended sanders. Sanding should be carried out in line with the seams. The waiting time between application of Sikaflex®-290 DC PRO and sanding is indicated in Fig. 44.

FINISHING

It is not recommended that a finish such as a varnish be applied to the exterior teak deck as these can contain solvents or plasticizers which can adversely affect the cured Sikaflex®-290 DC PRO or the drying of the lacquer. Varnishes do not often exhibit the flexible characteristics of a caulk, and so the finish may also show cracks, which could render the deck unsightly.

See also chapter "MAINTENANCE OF TEAK DECKS" on page 41.



Fig. 46 Sanding the deck

PREFABRICATED TEAK DECKS

Many shipyards appreciate the use of prefabricated teak decks because they can be manufactured off-site, rather than on board where the process can block other activities. Prefabricated panels are efficient in their versatility to be produced in various shapes, quickly or on demand; as soon as the panel manufacturer has obtained the dimensions of the boat deck production can be started, thus saving substantially on labour costs. The prefabricated panels are also very easy to handle and to bond to the deck.

TYPES OF PREFABRICATED TEAK DECKS

In modern boat-building wooden decorative decks are often constructed in the form of prefabricated panels bonded or bedded onto the sub deck. This method is often favoured for time and cost savings.

These kinds of panels are either made to measure (custom made) from a template fitting the prescribed deck section, or are cut out of unidirectional panels. Prefabricated teak deck panelling comes either with or without a backing.

BACKINGS MAY BE

- Marine plywood in different thickness
- HPL (flat laminate)
- Fiberglass lamination with epoxy resins

Plywood or HPL backing

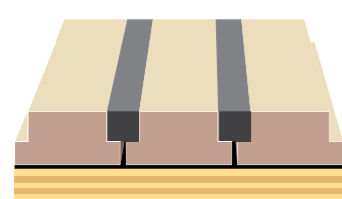
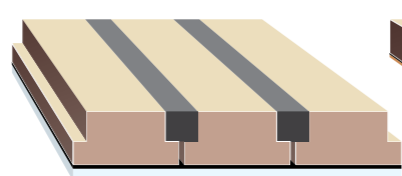

Fig. 50 Typical prefabricated teak deck profiles

GRP



Without backing

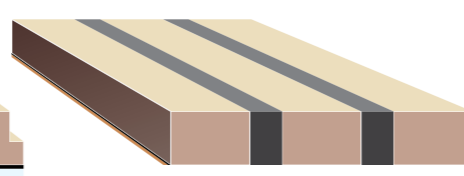

Fig. 47 Customised teak decking made to measure



Fig. 48 A prefabricated teak deck is laid out in preparation for fitting



Fig. 49 Deep joint prefabricated teak decking and the strength and flexibility inherent in the adhesive

BONDING OF THE PREFABRICATED ELEMENTS

To bond or bed the prefabricated panels, use one-component polyurethane adhesives such as Sikaflex®-298 or Sikaflex®-298 FC.

The adhesive has to act as an additional layer in between the sub deck and the panel in order to waterproof the overall surface of the deck. As a prefabricated feature deck does not have to be drilled for screws and bolts there is no puncturing of the layer and therefore no risk of water leakage which could damage the sub-deck.

SUBSTRATE PREPARATION

FIBREGLASS BACKINGS

- 208** Heavily soiled surfaces should first be cleaned off with a pure solvent (Sika® Remover-208) to remove the worst of the soiling
- Lightly abrade the contact area with an abrasive pad very fine
- Remove the dust with a vacuum cleaner
- Primer Treat the substrate with Sika® Primer-290 DC or Sika® MultiPrimer Marine, using a clean brush or roller
- Waiting time until deck bonding: 30 minutes (min) to 24 hours (max)

TIMBER OR PLYWOOD BACKINGS

- Abrade the contact area on the deck with a sanding pad (80 / 100 grit)
- Remove the dust with a vacuum cleaner
- Primer Apply a thin, continuous coat of Sika® Primer-290 DC or Sika® MultiPrimer Marine using a clean brush or a roller applicator
- Drying times: Sika® Primer-290 DC or Sika® MultiPrimer Marine 30 min to 24 hours

WITH HPL-BACKINGS

- Abrade the contact area on the deck with a sanding pad (60-80 grit)
- Remove the dust with a vacuum cleaner
- Primer Apply a thin, continuous coat of Sika® Primer-290 DC or Sika® MultiPrimer Marine using a clean brush or a roller
- Waiting time until deck bonding for Sika® Primer-290 DC or Sika® MultiPrimer Marine 30 min to 24 hours

WITHOUT BACKINGS

- Remove the dust with a vacuum cleaner
- Primer Apply a thin, continuous coat of Sika® Primer-290 DC or Sika® MultiPrimer Marine using a clean brush or a roller
- Waiting time until deck bonding for Sika® Primer-290 DC or Sika® MultiPrimer Marine 30 min to 24 hours

TWO-COMPONENT COATING ON METALS

- Ensure that the treated metal deck is compatible with Sikaflex®-298. Test the paint with a solvent like acetone or a commercial available silicon remover or paint thinner. If the paint can be removed, sandblast off the paint down to the metallic surface and use SikaCor® ZP Primer
- SA 100 Treat the substrate with Sika® Aktivator-100, using a clean lint free rag or paper towel. Change the rag frequently!
- Waiting time until deck bonding: 10 minutes (min) to 2 hours (max)

ALUMINUM OR STEEL DECKS

- Steel:** the surface must be ground or sand-blasted to remove rust, loose particles, flaked paint, contaminants, etc. When complete, remove all dust with a vacuum cleaner
- Aluminum:** This surface should be slightly sweep-blasted
- Thoroughly vacuum clean the surface
- SA 205 Treat the surface with Sika® Aktivator-205 with a lint free paper towel
- Flash-off: 10 minutes (min) to 2 hours (max)
- Avoid dust or other contamination until the next step has been carried out
- ZP Apply a continuous coating to the surface of SikaCor® ZP Primer within 2 hours of the Sika® Aktivator-205 treatment. Use a clean brush or a roller at a consumption of approx. 200 gm / m² or 80 µm thickness.
- Waiting time until deck bonding: 10 °C minimal 5 to 14 hours
20 °C minimal 3 to 14 hours
30 °C minimal 1 to 14 hours

APPLICATION AND POSITIONING OF THE PREFABRICATED DECK ELEMENTS

Sikaflex®-298 or Sikaflex®-298 FC is a low viscosity, exceptionally strong flexible one-component adhesive which is applied with a 4-5 mm comb trowel. The consumption should be around 1.2 litres (2x 600 ml sausages) per m². The quantity has to be adjusted according to the surface texture. In any case the planks have to be embedded totally without any air pockets between substrate and planks.

Remove the air after the element was laid down with a steel roller. Start in the middle of the deck towards the edge of the element.

BONDING PROCESS



298

Apply the adhesive to the previously prepared surface and spread it using a spreader with 4 mm triangular notches. The bed thickness may vary depending on the thickness of any gap that needs to be filled



If HPL or GRP-laminates have to be bonded, spray a light mist of water on the Sikaflex® prior to positioning the panels (about 1 g / m²). If one of the bonded partners is wood, the application of a water mist is not necessary but sometimes useful to accelerate the cure at lower temperature. The deck panel must be positioned accurately and pressed firmly into place. Use a roller to eliminate air pockets.



208

Uncured Sika adhesives or sealants should be removed with Sika® Remover-208 on non porous substrates. On porous substrates let harden the Sikaflex® soiled on teak and eliminate it mechanically.



Clamps, weights or screws (removable once the adhesive has set) can be used to secure the panel. Alternatively, the vacuum press method can be used.



After 24 hours the panels can carry their full service load and the temporary fastenings can be removed.

FINISHING

Remaining joints should be caulked as soon as the fixation means are removed. For horizontal joints, Sikaflex®-290 DC PRO can be used. Vertical joints should be caulked with Sikaflex®-295 UV.



IMPORTANT: If masking tapes are used, they have to be removed as soon as possible before skinning of the Sikaflex® occurs.



Fig. 51 Sealing the edges after renovation with Sikaflex®-295 UV



Fig. 52 Application of Sikaflex®-298



Fig. 53 Holding in place with weights

MAINTENANCE OF TEAK DECKS

The teak deck changes its color during exposure to the sun and will weather in time to a silver patina. The resulting greyish brown is sometimes wished. In such case we recommend to clean the deck surface regularly with Sika® Teak Cleaner. Use a sponge or a brush and work always in the direction of the wood grain. In warm climates this procedure should be carried out every day. Bleach, strong acids and aggressive chemicals should not be used at any time.

To maintain the colour and appearance of a new teak deck, Sika offers a maintenance system: Sika's Teak Maintenance System is fully compatible with Sikaflex®-290 DC PRO caulked teak decks.

Sika's Teak Maintenance System consists of the following:

SIKA® TEAK C+B BIO

This remove dirt, salt residue and oily pollution, as well as algae and it brightens natural weathered teak.

Apply directly to either wet or dry teak using a scrubbing brush and/or a cloth. Work always in the direction of the wood grain. Leave for 10 minutes before rinsing off with fresh water.

Important: Work in segments to avoid drying or too long reaction time.

SIKA® TEAK OIL NEUTRAL

Apply this with a clean rag, brush or roller to dry, cleaned wood and allow the oil to penetrate for about 30 minutes before removing the excess. Reapplication is recommended at the first signs of weathering.



Fig. 54 10 year old teak deck



Fig. 55 New teak deck



Fig. 56 Keep decks looking like new by using the appropriate maintenance products



Fig. 57 The Sika range of teak deck maintenance products

TEAK DECK REPAIR

Most quality timber decks are of teak. For this reason, most of the procedures outlined in this manual are focused on that material.

Deciding whether or not a wooden deck needs to be repaired is not always easy. First, it must be established that a joint has failed or that the wood has been damaged sufficiently to cause a problem.

Each and every joint should be closely inspected. Any points at which there is a small gap or crack in the caulk should be marked with distinctive chalk.

Similarly, the wood surface should also be closely examined for undue wear, gashes, splitting or splintering and should be marked with chalk in a similar way.

However, parts or all of damaged planks should be replaced, according to how badly they are damaged.

If joints are mostly in good condition, but are damaged in one or two places, these can be repaired by replacing the local caulk. More extensive damage, may suggest that all of the jointing would need to be replaced.

The following table shows the recommended responses to the outcome of a deck analysis.

	Serious wood damage	Slight wood damage	Wood undamaged
Serious joint damage	Replace deck with new prefabricated or built in-situ deck	Replace all joints, then sand and restore whole deck	Replace all joints
Slight joint damage	Replace damaged joint areas, replace damaged wood areas, then sand and restore whole deck	Replace damaged joint areas, then sand and restore whole deck	Replace damaged joints only
Joints undamaged	Replace damaged wood areas. Sand and restore whole deck	Sand and restore whole deck	Clean the deck. Restore the wood if necessary

Which repair solution will be chosen depends on the state of the deck and the expected result.

DECK ANALYSIS RESPONSES

Please note that water intrusion between wood and deck may lead to fouling of the wood. It is recommended to control the deck periodically and repair non tight areas before the whole deck is affected or part of the wood detaches from the deck due to the wood expansion with permanent water contact.

HOW TO DETECT UNTIGHT AREAS?

Wood that has become damaged by water trapped in a failed joint becomes more porous than the wood surrounding it. This can result in the damaged wood changing colour. It also means that it will remain wet after the rest of the deck has dried. Wetting the deck and closely examining the areas that remain wet after the rest has dried, is an effective method for identifying problem areas.



Fig. 58 Discolouration of the wood is a tell-tale sign of a failed or damaged joint in this teak deck

DETERMINATION OF THE TYPE OF ADHESIVE WHICH WILL BE REPLACED

In the following part all possible repair solutions are described. However to achieve a perfect result, the chemical composition of the original deck caulking material as well as the elastic adhesive of the planks have to be determined if they are not known.

One simple test is to observe the burning behaviour of the sealant or adhesive.

For that a small test piece of the test product will be ignited with a pocket lighter.

The type of flame, the flammability and the smoke gives a good indication of the product base.

	Flammable. Yellow flame with an intense black fume and black ashes indicates a polyurethane
	Flammable. Yellow flame without black fumes indicates a Product based on Hybrids or MS-polymers
	Non propagating light yellow flame with a white to grey fume and white ashes indicates a Silicon based product

If in doubt, consult your local Industry Department.

IMPORTANT: Never repair a joint simply by cutting the sealant out and replace it with a sealant unless the chemical base is identical.

REPAIR RECOMMENDATION

If the old joint is soft and sticky we recommend to eliminate the old material completely using a router. Enlarge the joint to ensure a proper wooden surface. After such a removal, **all sealant types** can be newly applied. Procedure of levelling, bonding and caulking of teak decks (see page 33-37).

REMOVING OF OLD CAULKING

There are four principal methods for removing old caulking. These are:

- Manual cutting with a sharp knife
- Using an oscillating cutter (Fein Tools) with a chisel-tip blade that is the same width as the joint
- Using an electrically heated rubber-cutting 'rubbercut' tool (Rema)
- Using a router. This method must be used if the old caulking material is not Sikaflex®-290 DC PRO as the sides of the joint will be shaved by the router blade

The method used normally reflects the size and the nature of the job. For a small, one-off job, the manual method would be the cheapest and the simplest method. A large job or a professional repair workshop would likely need to use either the oscillating cutter or the Rubbercut tool for both the time-saving and the quality of the finish.

The router would be used where it is necessary to make sure that there is no residue of the old caulking remaining. This would be especially important when the old caulking material is of unknown chemical composition as it might both have an unwelcome reaction with the new caulking material and have an inferior adherence to the sides of the joint.

OLD JOINT	NEW JOINT		
	PUR	MS / Hybrides	Silicones
PUR	Just cut out the defective joint. Pre-treat the surface to be resealed with Sika® Aktivator-100 and leave it for at least one hour before the application of the new sealant	Not recommended	Not recommended
MS or Hybrid	Not recommended	Seek advice from the manufacturer	Not recommended
Silicone	Not recommended	Not recommended	Cut out the defective material, clean with Isopropyl alcohol and seal the joints after 1 hour flash off time

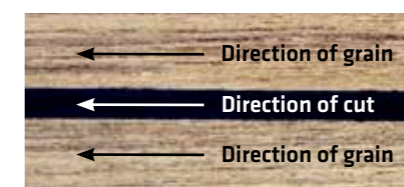

Fig. 59 Always ensure that the direction of cut is with the grain to avoid 'digging-in' damage to the sides of the planks

IMPORTANT: It is important to take care and ensure that the directions of cut is WITH the grain as shown in Fig. 59



Fig. 60 Using a craft knife to cut along the part of the joint to be removed

REMOVAL WITH A SHARP KNIFE

	Insert the blade of a craft knife into one side of the joint perpendicular to the deck surface	
Fig. 61 First cut using blade in left of joint at 90°		
	Cut along the joint taking care to keep the blade straight otherwise the wood might get damaged, or the old caulking will not be completely cut away	
Fig. 62 Second cut using blade in right of joint at about 45°		
	Insert the blade at an angle from the top of one side of the joint to the bottom of the other	
Fig. 63 Third cut using blade in right of cut at 90°		
	Cut along the joint taking care to keep the blade at a constant angle. This will remove a triangular bead of old caulking along the length of the joint	
Fig. 64 Fourth cut using blade at about 45° to the left		
	Insert the blade vertically at the other side of the joint. Once again, care should be taken to keep the blade straight otherwise the wood might get damaged, or the old caulking will not be completely cut away	
Fig. 65 Fifth cut using a scraper along the bottom of the joint		

REMOVAL WITH AN OSCILLATING CUTTER

	Switch on the oscillating cutter. Grind the blade with a grinding stone (from the tool manufacturer).	
Fig. 66 The oscillating cutter		
	Insert the blade in the joint and remove it. For this joints it may be necessary to do this in two steps.	
Fig. 67 Removal of joints		
	The cut caulking will be ejected out of the joint with a continuous strip.	
Fig. 68 Removal blades		

REMOVAL WITH AN ELECTRICAL RUBBERCUT TOOL

	Switch on the Rubbercut tool
	Exert a pressure to the cutting head in the forward direction. The tip will heat up to a temperature which cuts the old caulking
	Insert the tool and advance it along the joint, taking care not to damage the planks at the sides of the joint and in the case of smoking, insert a new cutting blade
	The cut caulking will be ejected out of the joint in a continuous strip



Fig. 69 The rubbercut tool



Fig. 70 Blades for rubbercut



Fig. 71 A triangular cut of the old caulking being removed manually

REPLACING OF OLD JOINTS

Old and damaged or detached sealants should be replaced to prevent water intrusion in between Teak and Substrate. One of the problems could be an incompatibility of the old sealants with the new joint sealant.

The best solution is to remove the old sealant completely using a guided router and the new sealant adheres to the teak-wood.

If the old sealant cannot be removed completely, an analyse of the old sealant should be done to detect possible incompatibilities between old and new sealant (see page 42)

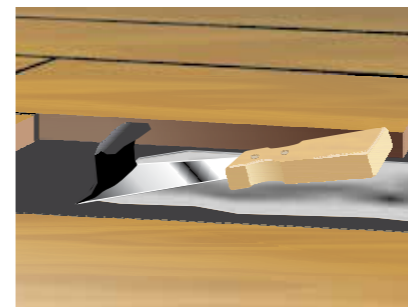

Fig. 72 Old bedding should first be scraped off using a scraper



Fig. 73 A useful and effective vibrating scraper power tool

REPLACING DEFECTIVE PLANKS

	Completely remove the caulking from the joints around any planks that are to be removed. (See 'Removing Old Caulking' on page 43). Identify the damaged planks with a chalk
	Remove the damaged plank, taking care not to damage the substrate. (If a strong adhesive has been used to bed the plank in place, it may be necessary to destroy the first plank removed in any series. The aperture can then be used to insert a shim beneath adjacent planks to enable their removal if necessary.)
	If only part of the plank is to be replaced. Cut off the damaged area using a vibrating saw. Prepare the new plank to the same dimensions as the damaged one
	Remove any old adhesives, bedding or other foreign matter from the substrate and remove the jointing material from around the edge using a craft knife, a scraper and sandpaper to ensure that the exposed edges are completely free of any residue
	Analyse the type of sealant. (see page 42)
	In case of silicone as original sealant, grind the edge of the planks or better using a router with a guide to assure a complete removal of the old sealant
	Dry fit the new plank to make sure that it will locate and align with the existing planks

	Clean, or if necessary, prime the substrate according to the type of material as described in the appropriate procedure
	Prime all faces of the remaining planking as well as of the new plank (including the hidden side) using Sika® Primer-290 DC or Sika® MultiPrimer Marine
	Drying time: 30 min to 24 h
	Apply and spread bedding compound Sikaflex®-298 or Sikaflex®-298 FC at the appropriate depth to the sub deck
	Insert the replacement plank, bedding it in place and aligning and levelling it carefully with existing planking
	Hold the new planking in position using weights, screws or wedges
	Allow the Sikaflex®-298 or Sikaflex®-298 FC to cure for a minimum period of 24 hrs
	Apply Sikaflex®-290 DC PRO caulking, ensuring that no air is trapped in the joints and allowing the compound to slightly overfill the gap
	Slightly overfill the joint. Leave it if the deck will be sanded after caulking or use a spatula at 60° angle to press the sealant slightly into the joint.
	Let the Sikaflex® 290 DC PRO cure as indicated in Fig. 44

IMPORTANT:
If the deck should not be grinded, the joint filling process can be done using masking tapes



1. Damaged area



2. Removed planks



3. Embedded new planks



4. Repaired deck



Fig. 74 Cutting planks with vibrating knife



Fig. 75 Picture Removal overstanding Sikaflex®-290 DC PRO with a vibrating scraper power tool



Fig. 76 Belt sander

SANDING OF THE DECK

To reduce sanding time we recommend to remove most of the hardened bead of Sikaflex®-290 DC PRO with an electric vibrating scraper

For efficient sanding results, use an industrial sander. It is recommended to begin with a medium paper at about 80. Suitable sanders are belt sanders, flat plate, or elastically suspended sanders

Connection areas may be sanded with a palm sander (see Fig. 77)

When the surface is uniformly smooth. Change the sanding belt to 120 grit and re-sand the whole area again, keeping the sander aligned with the wood grain as much as possible

Remove all dust with a vacuum cleaner

REPLACING THE WHOLE DECK

In such case the wood has to be removed and the deck has to be cleaned. Sanding or sandblasting has to be done down to the original substrate. Then install a new deck as outlined in chapter "PROCEDURE OF LEVELLING, BONDING AND CAULKING OF TEAK DECKS", pag. 33 and chapter "PREFABRICATED TEAK DECKS", pag. 38.



Fig. 77 palm sander

ALTERNATIVES TO TEAK

Teak has been used for hundreds of years as a durable deck material.

Alternatives for teak such as iroko, padouk etc. are used in some cases but necessitate an intensive protection work to assure a long time function. Usually they are used in workboats as thick protective floors.

Teak deck alternatives are shown in the chart beside

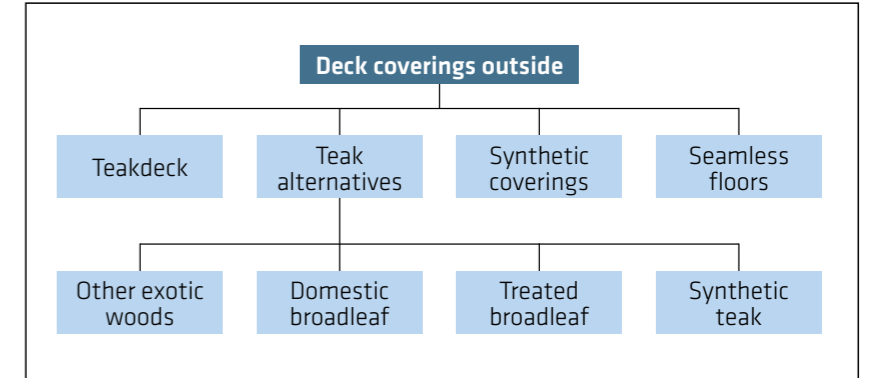

OTHER WOODS

ADVANTAGES:

- Not submitted to legislation (FSC-label)
- Good relation price / durability

DISADVANTAGES:

- Durability of these wood is lower than teak
- Shrinkage (hygric) is higher than teak
- No longtime experience in decking's are known
- More irregular grain such as alternating spiral growth etc. Periodical deck control is necessary.

Frequently used woods:



Iroko (Kambala)



Padouk

Others possible alternatives are: oregon pine, afromosia, basralocus, cedro, cordia, kahja, sipo, IPE etc.

IMPORTANT:
Decks done with these woods may show an irregular hygric movement. Such deck coverings have to be observed frequently and eventually noticed joint detachments have to be repaired immediately

Surface preparation are identical to the manufacture of a teak deck (see chapter "PROCEDURE OF LEVELLING, BONDING AND CAULKING OF TEAK DECKS").

TREATED BROADLEAF

This type of wood are home-grown broadleaf treated with natural or synthetic resins.

One example of these product types is Kebony. This is a maple wood treated with natural resins.

With this treatment the following characteristics are achieved:

- Durability comparable to teak with the same colour change to grey - brown
- Hardness, abrasion resistance higher than Teak
- Expansion property as teak

Surface preparation and adhesives are identical to chapter "PROCEDURE OF LEVELLING, BONDING AND CAULKING OF TEAK DECKS".

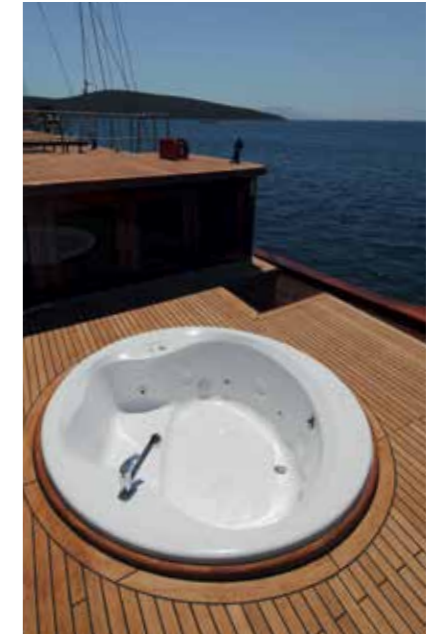

Fig. 78 Kebony new



Fig. 79 Kebony aged

SYNTHETIC (ENGINEERED) TEAK

Synthetic teak consists in thin layers of teak which are bonded together. The advantage of this process is the use of the entire tree. (Heartwood and sapwood).

Further information's have to be requested by the manufacturer.

SYNTHETIC COVERINGS

These prefabricated decks are made of different plastics. Quality and durability may differ as well as slip resistance and feel. These coverings are mainly used on yachts.

We distinguish between principally three types of synthetic coverings:

- Polyurethane elastomers / GRP backing
- Synthetic rubber composites
- PVC based coverings
- PU resins



Fig. 80 Different designs

PREPARING PUR BASED DECK COVERINGS

- The covering material must be free from release agents or other media used in the production process. Use appropriate solvent recommended by the manufacturer
- On nonporous coverings, the side that is to be bonded should be cleaned with Sika® Aktivator-100, using a clean, lint-free rag or a paper towel. Change the rag frequently!
- Flash-off: 10 minutes (min) to 2 hours (max)

PREPARATION OF THE DECK

GRP DECKS

- Heavily soiled surfaces should first be cleaned off with a pure solvent like, Sika® Remover-208, to remove the worst of the soiling
- Lightly abrade the contact area with a very fine sanding pad
- Remove the dust with a vacuum cleaner
- Clean the substrate with Sika® Aktivator-100, using a clean, lint-free rag or a paper towel. Change the rag frequently!
- Flash-off: 10 minutes (min) to 2 hours (max)

TIMBER DECKS

- Abrade the contact area on the deck with a sanding paper (80 / 100 grit)
- Remove the dust with a vacuum cleaner
- Apply a thin, continuous coat of Sika® Primer-290 DC or Sika® MultiPrimer Marine using a clean brush or a felt applicator.
- Drying times: Sika® Primer-290 DC or Sika® MultiPrimer Marine – 30 minutes (min) to 24 hours (max)

ALUMINUM OR STEEL DECKS

- Steel:** Grind (36 P grit) or sand-blast the surface in accordance with ISO 8501-1: 1996 SA 2 1/2
- Aluminum:** Lightly sweep-blast the surface
- Thoroughly vacuum clean the surface
- If the area is contaminated, treat the surface with Sika® Aktivator-205 using a clean towel
- Flash-off: 10 minutes (min) to 2 hours (max)
- Avoid dust or other contamination until the next step has been carried out
- Apply a continuous coating of two-component SikaCor® ZP Primer within 2 hours of the Sika® Aktivator-100 treatment to the surface, using a clean brush or a roller at a consumption of approx. 200 gr / m² or 80 µm thickness.

ALUMINUM OR STEEL DECKS, COATED WITH A TWO-COMPONENT PAINT, VARNISH OR FAIRING COMPOUND

- Ensure that the treated metal deck is compatible with Sikaflex®-298. Test the paint with a solvent like acetone or a commercial available silicon remover or paint thinner. If the paint can be removed, sand-blast off the paint down to the metallic surface and use SikaCor® ZP Primer (see page 33)
- Lightly abrade the contact area with a very fine abrasive pad
- Treat the substrate with Sika® Aktivator-100, using a clean, lint-free rag or paper towel. Change the rag frequently!
- Flash-off: 10 minutes (min) to 2 hours (max)

For the preparation of other substrates, please refer to the Pre-Treatment Charts for Sika Marine Applications.

BONDING PROCESS

- Apply Sikaflex®-298 on the previously prepared surface and spread using a spreader with 4 mm comb trowel. The thickness layer should be about 1.2 mm, 2x 600 ml saucages per m².
- The covering material must be placed in position within 20-30 minutes of applying the adhesive, therefore the adhesive should be applied only to an area large enough to receive the section of covering that can be fitted in this time. Prevent air entrapment!
- Once the covering has been placed in position it should be rolled down with a rubber roller, working from the centre outwards to expel any entrapped air and push any excess adhesive out to the edges, where it can be removed. It is essential to ensure that no trapped air remains
To accelerate the curing process we recommend to apply a mist of water using a paint gun. Do it sparingly as Sikaflex® needs only 1 gram of water per square meter.
Caution: If the covering material is laid under tension, the edges must be held or suitably weighted
- Fix the deck with weights or vacuum press over night
- Uncured Sikaflex® may be removed from Tools with Sika® Remover-208. On rough surfaces we recommend to leave the adhesive to cure and remove it mechanically

PVC-COVERINGS

Most of the alternatives for teak decks are based on PVC. The composition varies for each deckings. PVC coverings contain organic plasticizer. This plasticizer may have an long time interaction with the used adhesive. Therefore we do not give any recommendation for bonding such products. In such case it is best to get in contact with the distributor in order to receive an adhesive which is recommended by the manufacturer.

IMPORTANT:
Due to the variety of the deck coverings we recommend to seek advice from the procedure of the coverings or contact your local Technical Service department, Sika Industry.

BONDING OF TIMBER ELEMENTS

In yachts and pleasure craft as well as in ocean-going vessels, stairs, companionways and handrails are frequently made from tropical hardwood, chosen both for their durability and their attractive appearance.

The use of screws to attach these fixtures can impair both their durability and their appearance as they are vulnerable to moisture gaining access through the fixing holes. Hardwood components like these can be fixed with adhesives, where the absence of screw holes leaves the wood unimpaired and more resistant. This is of particular importance where the wood is load bearing as in the construction of accommodation ladders.







Bonding also has other benefits. The resilient adhesive layer softens the sound of footsteps and cushions vibrations, the integrity of painted surfaces can be preserved without loss of corrosion protection and the effects of moisture penetration are eliminated.

The Sika products for bonding timber elements are Sikaflex®-298 or Sikaflex®-298 FC (low viscous) for big bonding parts or parts which do not need an instant fixation until the hardening process took place (horizontal applications).







SUBSTRATE PREPARATION





GRP

-  208 Heavily soiled surfaces should first be cleaned off with Sika® Remover-208 to remove the worst of the soiling
-  Lightly abrade the contact area with a very fine sanding pad (abrasive pad very fine)
-  Remove the dust with a vacuum cleaner
-  SA 205 Treat the substrate with Sika® Aktivator-205, using a clean, lint-free rag or paper towel. Change the rag frequently!
-  Flash-off: 10 minutes (min) to 2 hours (max)
-  Primer Apply a thin, continuous coat of Sika® Primer-290 DC or Sika® MultiPrimer Marine using a clean brush or a felt applicator
-  Drying time: 30 minutes (min) to 24 hours (max)







METALL DECK COATED WITH A 2 C-PAINT

-  Ensure that the painted metal deck is compatible with Sikaflex®-298. Test the surface with a rag and thinner. The paint should not be removable by this operation. When the paint is disolvable sandblast off the paint down to the metallic surface and use SikaCor® ZP Primer (see page 33)
-  Lightly abrade the contact area with a very fine sanding pad (Scotch Brite very fine)
-  Remove all dust with a vacuum cleaner
-  SA 100 Treat the substrate with Sika® Aktivator-100, using a clean lint-free rag or paper towel. Change the rag frequently!
-  Flash-off: 10 minutes (min) to 2 hours (max)

UNTREATED WOOD

-  If the surface is soiled, abrade the contact area with a sanding pad (80 / 100 grit)
-  Remove the dust with a vacuum cleaner
-  Primer Apply a thin, continuous coat of Sika® Primer-290 DC or Sika® MultiPrimer Marine, using a clean brush or a felt applicator
-  Drying time: 30 minutes (min) to 24 hours (max)

STAINLESS STEEL

-  208 Heavily soiled surfaces should first be cleaned off with Sika® Remover-208 to remove the worst of the soiling
-  Lightly abrade the contact area with a very fine abrasive pad (abrasive pad very fine)
-  Clean with a proper rag or a vacuum cleaner
-  SA 100 Pre-treat the substrates with Sika® Aktivator-100, using a clean, lint-free rag or a paper towel. Change the rag frequently!
-  Flash-off: 10 minutes (min) to 2 hours (max)
-  Primer Apply a thin, continuous coat of Sika® Primer-290 DC or Sika® MultiPrimer Marine using a clean brush or a felt applicator
-  Drying time: 30 minutes (min) to 24 hours (max)

APPLICATION OF Sikaflex®-298

The choice whether you use Sikaflex®-2xx or -298 depends on the parts to be bonded.

Big horizontal areas are better to bond with Sikaflex®-298 as this low viscous product is easier to apply with a trowel. The bedding process should be made with weights or with a vacuum press.

Smaller parts, inclines on vertical applications, or parts which have to be fixed with a vacuum press are best to be bonded with Sikaflex®-2xx. The higher viscosity of this product prevents a squirring out during vacuum application.



-  291i Apply Sikaflex® with a notched trowel on the prepared surface. Use a notched trowel with 4 mm rectangular notches depending of the roughness of the substrates
-  291i The thickness of the layer depends on the roughness of the surface but has to be at least 1.2 mm (2 sausages 600 ml / m²)
-  Apply the timber within the open time of 15 minutes. Fix the components for 24 hours



Fig. 81 Application of Sikaflex®-298

IMPORTANT: it is essential that the elements are completely pressed down to the substrate to avoid water penetration underneath the timber element. This may create fouling and subsequent degradation of the wood.

Remove cured excess Sikaflex®-2xx with a knife and seal the edge without additional pre-treatment.

If necessary joints on the side of the elements may be sealed with a weathering resistant sealant like Sikaflex®-295 UV.

DISCLAIMER

The information, and, in particular, the recommendations relating to the application and end-use of Sika products, are given in good faith based on Sika's current knowledge and experience of the products when properly stored, handled and applied under normal conditions. In practice, the differences in materials, substrates and actual site conditions are such that no warranty in respect of merchantability or of fitness for a particular purpose, nor any liability arising out of any legal relationship whatsoever, can be inferred either from this information, or from any written recommendations, or from any other advice offered.

The proprietary rights of third parties must be observed. All orders are accepted subject to our current terms of sale and delivery. Users should always refer to the most recent issue of the Sika Product Datasheet for the product concerned, copies of which will be supplied on request.

A photograph of several sailboats racing on the water. The boats have white hulls with blue stripes and are sailing on a dark blue sea. The background shows a rocky coastline under a clear sky. The text is overlaid on a semi-transparent white box in the upper left corner.

SIKA MARINE APPLICATION GUIDE GENERAL MARINE ELASTIC BONDING APPLICATIONS

CONTENT

54 Bedding and Sealing Fittings and Hardware

56 Bonding of Rub Rails and Fenders

58 Bonding Decorative Panels and Work Surfaces

60 Bonding Lightweight Internal Partitions

62 Elastic Thick Layer Bonding



BEDDING AND SEALING FITTINGS AND HARDWARE

GENERAL DESCRIPTION

All kinds of deck fittings and hardware need to be securely fixed and totally watertight. Some of these fittings can be subject to very high forces, such as tensile, torsion and shear stresses. Poorly sealed joints can suffer serious damage such as metal corrosion, osmosis and water leaks which can cause damage to interior furnishings and fittings.

BEDDING AND SEALING OF FITTINGS SUBJECT TO HIGH MECHANICAL STRESSES

Deck fittings such as chain plates, winches and guide rollers must absorb very high dynamic stresses.

For this purpose a high-performance product, such as Sikaflex®-292i, should be used in conjunction with additional mechanical fixings.

BEDDING AND SEALING OF FITTINGS SUBJECT TO MINIMAL MECHANICAL STRESSES

Deck fittings, such as ventilators and cover strips, need to be waterproofed, but are not subject to high tensile or torsion stresses.

These fittings can be effectively bedded and sealed with only Sikaflex®-291i or if the joint remains visible and is exposed to weathering, the use of Sikaflex®-295 UV is recommended.

BEDDING AND SEALING FITTINGS AND HARDWARE

SUBSTRATE PREPARATION

TIMBER DECKS

- Abrade the contact area on the deck with a sanding pad (80 / 100 grit)
- Remove the dust with a vacuum cleaner
- Apply a thin, continuous coat of Sika® MultiPrimer Marine using a clean brush or a roller felt applicator.
- Drying times: Sika® MultiPrimer Marine 30 minutes (min) to 24 hours (max)

PAINTED DECKS

- Pre-treat the substrate with Sika® Aktivator-100, using a clean, lint-free rag or a paper towel. Change the rag frequently!
- Flash-off: 10 minutes (min) to 2 hours (max)

BRONZE, BRASS OR STAINLESS STEEL FITTINGS

- Slightly abrade the contact area with a very fine sanding paper or abrasive pad
- Pre-treat the substrate with Sika® Aktivator-100, using a clean, lint-free rag or a paper towel. Change the rag frequently!
- Flash-off: 10 minutes (min) to 2 hours (max)
- Apply a thin, continuous coat of Sika® MultiPrimer Marine using a clean brush or a felt applicator
- Drying time: 30 minutes (min) to 24 hours (max)

For coloured metals please use only Sikaflex®-295 UV or Sikaflex®-591.

ALUMINUM FITTINGS

- Lightly abrade the contact area with a very fine sanding paper
- Pre-treat the substrate with Sika® Aktivator-100, using a clean, lint-free rag or a paper towel. Change the rag frequently!
- Flash-off: 10 minutes (min) to 2 hours (max)
- Apply a thin, continuous coat of Sika® MultiPrimer Marine, using a clean brush or a felt applicator
- Drying time: 30 minutes (min) to 24 hours (max)

APPLICATION OF Sikaflex®-291i, -292i OR -295 UV ADHESIVES

- Mask the surrounding area before priming and sealing
- These adhesives should be applied to the deck and to the screw fixing holes in a bead of the required thickness. The fitting should then be pressed into position
- The fixing screws should be tightened slightly to leave about 1 mm of adhesive under the fitting
- Use a plastic spatula to remove excess sealant squeezed out around the edges and remove the masking tape
- After 24 hours tighten the screws

IMPORTANT: For the preparation of other substrates, please refer to the Sika Pre-Treatment Charts for Marine Applications.



Fig. 82 A selection of cleats that can be sealed or bonded using Sika adhesives



Fig. 83 Applying Sikaflex®-292i



Fig. 84 A port-hatch, both bonded and sealed using Sikaflex®



BONDING OF RUB RAILS AND FENDERS

GENERAL DESCRIPTION

Rub rails and fenders are designed to protect the hull of a vessel against damage. These act as a bumper to absorb impacts and scrapes, and the more elastic these are, the more effectively they perform this function.

The elastic behaviour varies according to the type of material used, so the shock-absorbing performance of the rub rail can be significantly improved by the use of an elastic adhesive joint. This provides maximum protection to the hull.

Rub rails of timber, PVC or polyurethane can be securely bonded to marine hulls using Sikaflex®-292i. The resulting elastic joint helps to absorb most of the shear and tensile stresses to which they are subjected when a vessel is docking or casting off.







If rub rails are secured with screws, a similar effect can be obtained by back-filling the rail profile with Sikaflex®-291i; a highly elastic polyurethane sealant. As well as absorbing torsional stresses, this technology also seals the screw holes and prevents water or dirt from getting behind the rub rail.

IMPORTANT:
If the rub rail has a different chemical composition and is not fixed using a mechanical fixing method, please seek advice from your local Sika company.



BONDING RUB RAILS TO THE HULL

SUBSTRATE PREPARATION





GRP HULLS

-  208 Heavily soiled surfaces should first be cleaned off with a pure solvent, like Sika® Remover-208, to remove the worst of the soiling
-  Lightly abrade the contact area with a very fine sanding pad
-  Remove the dust with a vacuum cleaner
-  SA 100 Pre-treat the substrate with Sika® Aktivator-100, using a clean, lint-free rag or a paper towel. Change the rag frequently!
-  Flash-off: 10 minutes (min) to 2 hours (max)
-  SMM Apply a thin, continuous coat of Sika® MultiPrimer Marine, using a clean brush or a felt applicator
-  Drying time: 30 minutes (min) to 24 hours (max)







FINISHED PAINTED HULLS OF ALUMINUM OR STEEL, COATED WITH A TWO-PART LACQUER

-  SA 100 Pre-treat the substrate with Sika® Aktivator-100, using a clean, lint-free rag or a paper towel. Change the rag frequently!
-  Flash-off: 10 minutes (min) to 2 hours (max)









TIMBER RUB RAILS

-  Abrade the contact area of the hull with a sanding pad (80 / 100 grit)
-  Remove the dust with a vacuum cleaner
-  SMM Apply a thin, continuous coat of Sika® MultiPrimer Marine using a clean brush or a felt applicator.
-  Drying times: Sika® MultiPrimer Marine 30 minutes (min) to 24 hours (max)

MOULDED PVC OR POLYURETHANE RUB RAILS

-  The bond face of the rub rails must be free from mould release agents or other chemical contaminants. All traces of such substances must be removed before proceeding with Sika® Remover-208
-  Abrade the bond face of the rub rail with coarse sand paper (60 / 80 grit) to key the surface
-  SA 205 Pre-treat the substrate with Sika® Aktivator-205 using a lint-free rag or paper towel. Change rag frequently.
-  Flash-off min. 10 min to max 2h.
-  SMM Apply a thin continuous coat of Sika® MultiPrimer Marine using a clean brush or felt applicator
-  Drying time: 30 minutes (min) to 24 hours (max)

APPLICATION OF Sikaflex®-292i OR Sikaflex®-291i

-  Apply a masking tape on the substrate
-  292i 291i Apply Sikaflex®-292i (or Sikaflex®-291i if rub rails are to be held using additional mechanical fixings) to the bond area using an appropriate triangular bead (Fig.82)
-  Assemble the components within 20 minutes of applying the adhesive
-  Press the rub rail into place, either directly onto the face of the hull
-  Use clamps, etc., to hold the rub rail in position while the adhesive sets. If the rub rail is to be secured with mechanical fixings, any holes should also be filled with adhesive
-  Remove excessive adhesive and the masking tape
-  208 Uncured Sika adhesives or sealants can be removed with Sika® Remover-208
-  Clamps and other fastening aids can be removed after 24 hours. Full service strength is attained after approximately 7 days

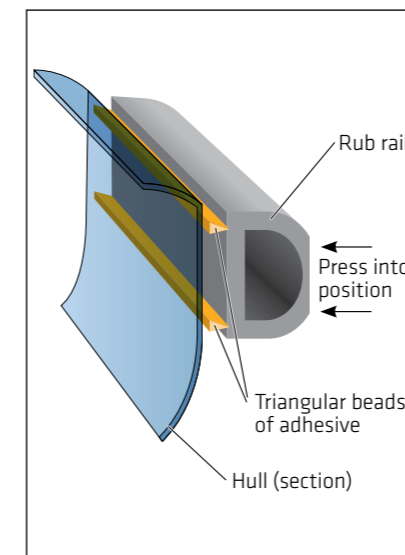

Fig. 85 Assembly of a rub rail

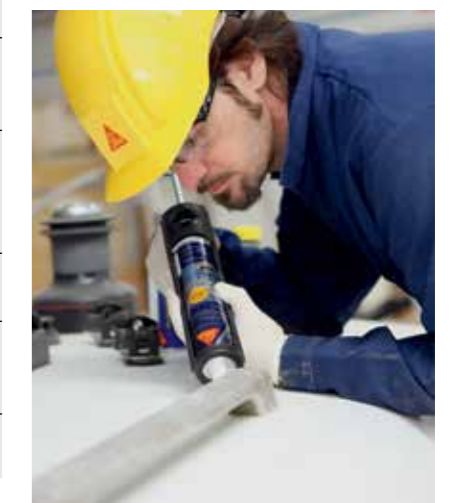

Fig. 86 Sealing the edge of a chrome hand-rail



BONDING DECORATIVE PANELS AND WORK SURFACES

GENERAL DESCRIPTION



The interiors of many boats are based on a variety of traditional and modern materials including mirrored glass. These panels can be used functionally as working surfaces (galley worktops, etc.) or cosmetically. Either way, elastic bonding provides an easy, durable method of fixing without visible and unsightly mechanical fixings.

As the variety of materials used for panels, surfaces and supporting substrates is so vast, please consult the local Technical Service of Sika Industry or proceed to preliminary trials.









BONDING DECORATIVE PANELS AND TABLES

SURFACE PREPARATION

-  Lightly abrade the bonding area with a very fine abrasive pad
-  Apply a thin continuous coat of Sika® MultiPrimer Marine using a clean brush or felt applicator
-  Sika® MultiPrimer Marine 30 minutes (min) to 24 hours (max)

APPLICATION OF Sikaflex® ADHESIVE TO VERTICAL PANELS

-  Prepare the substrate according to the Pre-Treatment Chart for Marine Application
-  Place spacers in position (thickness 2 mm, approximately 50 Shore A hardness). These can be pressed into the adhesive once applied
-  Apply appropriate beads of Sikaflex®-292i in an 8 mm x 10 mm triangular profile
-  Assemble the components within 20 minutes of applying the adhesive
-  Apply pressure with fastening aids to compress the adhesive to the height of the spacers
-  Wait at least 24 hours before walking on the bonded plates
-  Uncured Sika adhesives or sealants can be removed with Sika® Remover-208

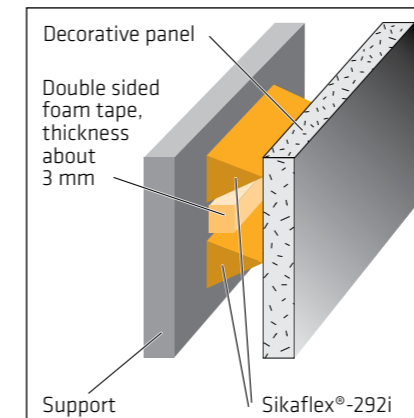









Fig. 87 Bonding a decorative panel vertically

APPLICATION OF Sikaflex® ADHESIVE TO HORIZONTAL PANELS

-  Horizontal surfaces: Sikaflex®-298. Inclined surfaces: Sikaflex®-291i
 -  Slightly abrade the surface with a abrasive pad very fine
 -  Pre-treat the surface with Sika® Aktivator-205 using a lint-free rag or paper towel. Change the rag frequently!
 -  Flash-off time min. 10 min to max. 2 h
 -  Apply adhesive to the previously prepared surface and spread over the area to be covered, using a spreader with 4 mm triangular notches. The bed thickness may vary depending on the thickness of any gaps that needs to be filled (normally 1-2 mm)
 -  If vapour-tight substrates are used, spray a fine mist of water (1 g / m²) onto the Sikaflex®-298 surface for faster curing
 -  The deck panel must be positioned accurately within the tack free time of the adhesive and pressed firmly into place to avoid air-entrapment
- Clamps, weights or screws (removable once the adhesive has set) can be used to secure the panel while the adhesive sets. After about 24 hours the panels can carry their full service load and the temporary fastenings can be removed

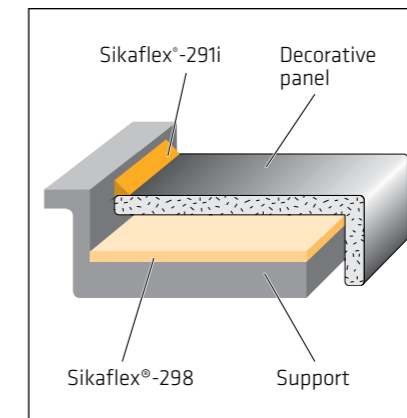

Fig. 88 Bonding a decorative panel vertically



Fig. 89 A galley work surface fitted using Sikaflex®-292i

IMPORTANT: Always refer to the current Sika Product Datasheets and Safety Datasheets obtainable through your local Sika company



Fig. 90 Application of Sikaflex®-291i



BONDING LIGHTWEIGHT INTERNAL PARTITIONS

GENERAL DESCRIPTION

These lightweight panels are usually constructed of wood sandwiches with internal polyurethane foam or honeycomb core. They are particularly suited as partitions for cabins and technical rooms as they are of lighter weight than wood filled panels and have good soundproofing properties.

Due to the low density core, lightweight panels cannot be mechanically fixed to the hull structures in the same way as traditional plywood panels.

However, bonding with Sikaflex®-292i is an ideal replacement fixing method that also possesses the flexibility to respond to the movements and stresses of the assembly.

The uniform stress distribution prevents damages which may be result of stress concentration (example screw).

This process is also endorsed by the manufacturers of the lightweight panels.

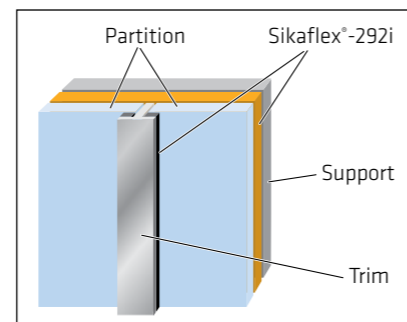

Fig. 91 Sikaflex®-292i bead application for bonding to the support

BONDING LIGHTWEIGHT INTERNAL PARTITIONS

SUBSTRATE PREPARATION

Please refer to the Sika Pre-Treatment Chart for Marine Applications.

APPLICATION OF Sikaflex®-292i ADHESIVE







-  Dry fit the panels to ensure an accurate fit and correct dimensioning. Prepare the surface accordingly
-  Place the spacers in position (thickness typically 3 mm, approximately 50 Shore A hardness)
-  Apply Sikaflex®-292i to the appropriate bond face using an appropriate bead
-  Assemble the components within 20 minutes of applying the adhesive
-  Uncured Sika adhesives or sealants may be removed with Sika® Remover-208
-  Panels can be held in place during cure by clamps or support brackets
-  Clamps and other fastening aids can be removed after 24 hours



Fig. 92 Sikaflex®-292i applied to a lightweight panel prior to fitting



Fig. 93 Lightweight panels being fitted to an open hull



Fig. 94 High-quality lightweight panels finished in traditional high-gloss wood veneer and bonded using Sikaflex®-292i



ELASTIC THICK LAYER BONDING

INTRODUCTION

From the earliest of times, boat construction has relied upon the available technology. Structural members needed to be attached to one another and everything would depend on the reliability of the bond.

Trial and error would have exposed the weaknesses in design and construction and one of the costs would have been the loss of the vessel, if not of lives.

As knowledge and experience was shared, so technology improved and in a symbiotic advancement, boat building and other industries benefited.

Today, significant advances in adhesive technology have spurred a revolution in assembly techniques across all of industry. But none reap the benefits more than the marine industry.

APPLICATION DESCRIPTION

Elastic thick layer bonding in respect of this manual refers to the method of joining the main structural components or components that contribute to the strength and stability of the structure of the vessel.

Elastic thick layer bonding is responsible for a completely different approach to vessel design. Whereas earlier techniques worked from a rigid skeleton that had to be strong enough to support the deck, hull, superstructure, windows, and fittings, the new approach uses all of these major components as the primary structural members and uses the old skeletal parts in a lighter form to provide stiffening to the structure.

Each time that a screw was used to hold a major component to the skeleton, it introduced weaknesses in every part it

passed through and became a focal point for stresses.

Marine architects had to take this into consideration during the design phase and ensure that there were sufficient fixings placed evenly along the joint lines in order to distribute the stresses. The location, size and type of every screw had to be specified, drawn onto the plans, bought in and stored.

The laminating method (taping) provides a far better alternative to this approach in most applications, with fewer components, a simplified design and better stress distribution. But this method is highly labour intensive and comes with numerous health and safety issues.

Elastic thick layer bonding from Sika is relatively simple to design, tolerant of dissimilar materials, very strong and durable, and besides having few health and safety requirements, takes a fraction of the time of other techniques to assemble.

In service, the inherent flexibility of the Sika structural adhesives evenly distributes the stresses and the lightweight construction techniques result in a major weight saving and corresponding buoyancy and performance increase in the vessel.

For every structural application, national and international rules, regulations and approvals must be observed.

DISCLAIMER

The information, and, in particular, the recommendations relating to the application and end-use of Sika products, are given in good faith based on Sika's current knowledge and experience of the products when properly stored, handled and applied under normal conditions. In practice, the differences in materials, substrates and actual site conditions are such that no warranty in respect of merchantability or of fitness for a particular purpose, nor any liability arising out of

any legal relationship whatsoever, can be inferred either from this information, or from any written recommendations, or from any other advice offered.

The proprietary rights of third parties must be observed. All orders are accepted subject to our current terms of sale and delivery. Users should always refer to the most recent issue of the Sika Product Datasheet for the product concerned, copies of which will be supplied on request.



SIKA MARINE APPLICATION GUIDE STRUCTURAL BONDING MARINE APPLICATIONS



CONTENT

66 Sika Solutions for Structural Bonding

68 Direct Glazing

71 Bonding and Sealing Organic Windows

74 Bonding and Sealing Mineral Glazing

77 Flybridge Bonding

79 Deck and Keel to Hull Bonding



SIKA SOLUTIONS FOR STRUCTURAL BONDING

MATERIALS AND TECHNOLOGIES

The main property of elastic bonding adhesives is that they are capable to support high mechanical stresses.

This single detail gives rise to concerns regarding the finished vessel in service, where, despite the improved assembly benefits, there can still be localised stress issues and a greater possibility of joint fracture due to impact or crushing forces.

Following extensive research, Sika has found that by introducing a degree of flexibility, these problems are greatly improved.

The Sikaflex® elastic adhesives for structural bonding are:

- Sikaflex®-292i
- Sikaflex®-296
- Sikaflex®-295 UV

Sikaflex®-292i is used to bond flybridges and keels as each of these can be subject to far greater local forces than other main components. The greater flexibility in these cases means that there will be greater 'give' in the first instance. The members would be more likely to be pulled off the vessel whole, without ripping pieces from the hull or superstructure. This also means that there is every chance that the components can be refitted without needing to be replaced.

Sikaflex®-295 UV and -296 are each used for glazing, as windows are increasingly used as structural members. Sikaflex®-295 UV is used for organic glazing and backfilling and Sikaflex®-296 is used for mineral glazing. In both cases the greater flexibility is to prevent forces being transmitted to the glazing that would otherwise damage it.

The following examples show the capability of the Sikaflex® Marine adhesives. However the custom tailored characteristics gives naval engineers and constructors the possibility of economic and sustainable new realisations. Sika will be happy to support you in the development and testing of new applications.

		MECHANICAL FIXING	LAMINATING TAPING	ELASTIC BONDING
MANUFACTURING	Time consumption	●	●	○
	Material cost	●	●	●
	Process complexity	● / ●	●	●
	Health / safety / environment	● / ○	●	●
	Tolerance gapping	●	●	●
	Assembling different (lightweight) materials	●	●	●
FINAL PERFORMANCE	Durability / fatigue resistance	○	●	●
	Durability / corrosion resistance	●	●	●
	Weight reduction	●	●	●
	Comfort (acoustics)	●	●	●

● Very good ● Good ○ Neutral ● Poor ● Very poor





DIRECT GLAZING

DESCRIPTION

Traditional glazing methods have evolved as they had due to the limitations in the performance of the glass. A sturdy window frame was required to hold the glass in place and to protect it from forces that would shatter it. Also, the size of a window was limited for similar reasons and a broken window in heavy weather could compromise the safety of the vessel.

In addition marine regulations define the areas on the ship where bonding of windows is allowed and where additional mechanical fixations are necessary. It is therefore of interest to contact a Classification Society in case of vessels which are submitted to IMO and SOLAS or other national rules.

Modern glazing can be realised with mineral and organic glasses. The manu-

facturing techniques allow windows of superlative performance to be produced in almost any shape, size and curvature to give designers the possibility of modern realisation of ships.

The traditional role of glazing as protection against the elements whilst allowing light and vision to pass through, has been extended to include the extra benefit of structural member.

Direct glazing, using peripherally applied structural adhesive systems, has become the primary method of installing windows due to the extensive list of benefits:

- Better protection against the elements than framed windows.
- Significantly improved design and styling capabilities for the marine architect by elimination of trim, frame and screws.
- Enlarged window area permits a more imaginative styling.
- Lower weight reduces running costs and improves speed.
- Fewer materials required reduce the cost of the build with lower component cost and quicker assembly times.
- Improved torsion stiffness of the boat.
- Reduction of the natural frequencies and vibrations, leading to an improved ride comfort.
- Improved aerodynamics reducing wind noise in operation.
- Better bridging of tolerances which has the advantages of quicker assembly and reduced adjustment costs.
- Greatly reduced production times leading to quicker delivery and lower labour costs.
- Fewer glass breakages both during construction and in operation.
- Easy repair at any place due to Sika's global presence.

DESIGN DIRECTIVES

Direct glazing represents a straight-forward process whereby the glass is bonded directly to the body of the vessel. This must comply with all industry standards as laid down by the governing bodies, such as the classification societies, in each respective country. Specific details are described as appropriate for mineral and organic glazing later in this manual, but the general criteria are described following.

UV PROTECTION

The bond line material must be protected from direct UV radiation as this causes deterioration of the chemical composition leading to failure. This is normally carried out by including a light impermeable mask as part of the design of the window. This can appear in the form of:

- Ceramic coating (peripheral) for mineral glass
- UV impervious paint or ink for organic glass
- External trim

The black silk screened ceramic border around the edge of the window is often feathered towards the centre of the window using various dot densities, resulting in an attractive shading effect. Adhesives can also be protected using external trim that is large enough to keep out the ultraviolet light and is also attractively designed such to enhance the appearance of the finish.

See page 72 for organic glass and page 75 for mineral glass for dimensioning the adhesive layer.

FITTING DIMENSIONS

Not only does the window have to fit correctly into the allotted aperture during assembly, but it must also take into account the changes that occur to the superstructure and the window under operating conditions.

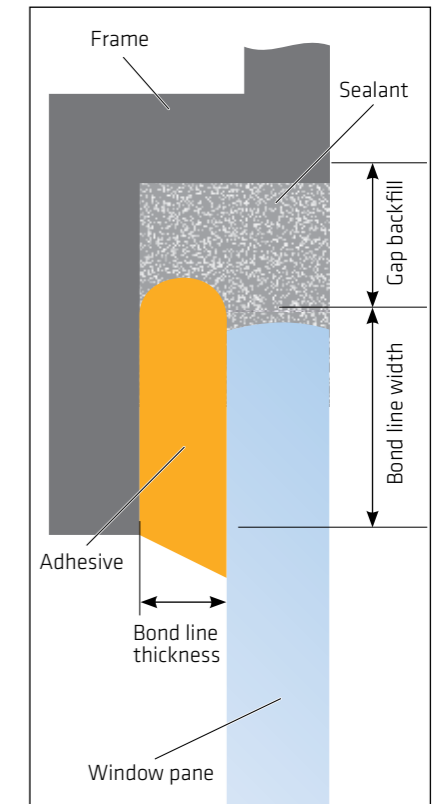

Fig. 96 Bonding a decorative panel vertically

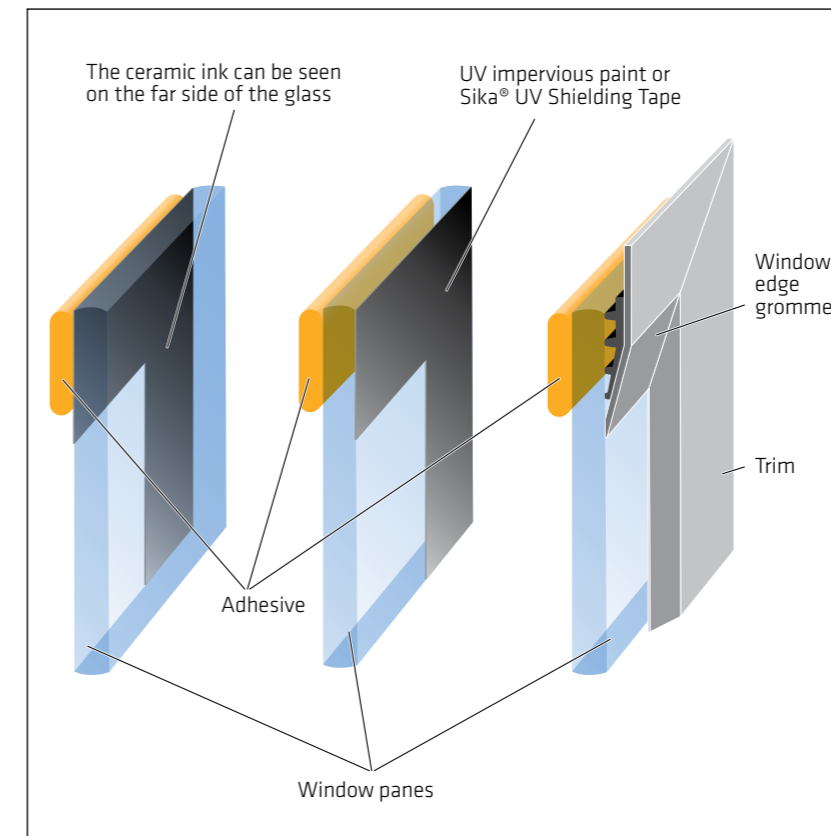

Fig. 95 Bonding a decorative panel vertically

BOND LINE WIDTH

The overlapping area between the frame and the glazing, known as the bond line width, should be large enough to allow sufficient adhesive to bear the weight of the glazing, as well as the suction load and head pressure to which the environment exposes it. A dimensioning guide is provided adjacent to the different procedures for mineral and organic windows.

BOND LINE THICKNESS

After it has set, the adhesive remains flexible. However, if too thinly applied, the adhesive may shear due to the changes in dimension caused by differences in thermal coefficient of expansion between the glazing and the superstructure and also the natural flexing between the glazing and the window frame in the varying sea conditions. Sika's dimensioning guide provided adjacent to the appropriate procedures determines the depth of spacers required to be placed within the adhesive to keep the distance equal to or greater than the minimum depth required to ensure the reliability and longevity of the adhesive and the bond.

GAP BACKFILLING

Around the edge of the glazing, there should be a gap sufficient to prevent contact between the glazing and the window frame for all temperatures and under all mechanical strains. A dimensioning guide is provided adjacent to the appropriate procedures.

SURFACE PREPARATION

The adhesion properties between the glazing and the window mounting material must be verified by Sika's Technical Department to ensure that the correct materials, solutions and methods are used and followed. Procedure for organic and for mineral glass are described on the following pages. Improperly prepared surfaces could result in failure of the bond and may put the safety of the vessel in jeopardy.

The high quality of Sika products is guaranteed and whereas Sika cannot vouch for the quality or compatibility of other manufacturer's products, only Sika primers, cleaners and adhesion promoters should be used with Sika adhesives and sealants.

PRIMERS AND CLEANERS

Flash off times for cleaners and primers must be strictly observed.

PRODUCT SELECTION FOR BOTH MINERAL AND ORGANIC WINDOWS

Selection of the correct surface preparation system is of utmost importance; as is the selection of the correct adhesive. These both depend on the type of window to be installed. The following table shows which adhesive should be used:

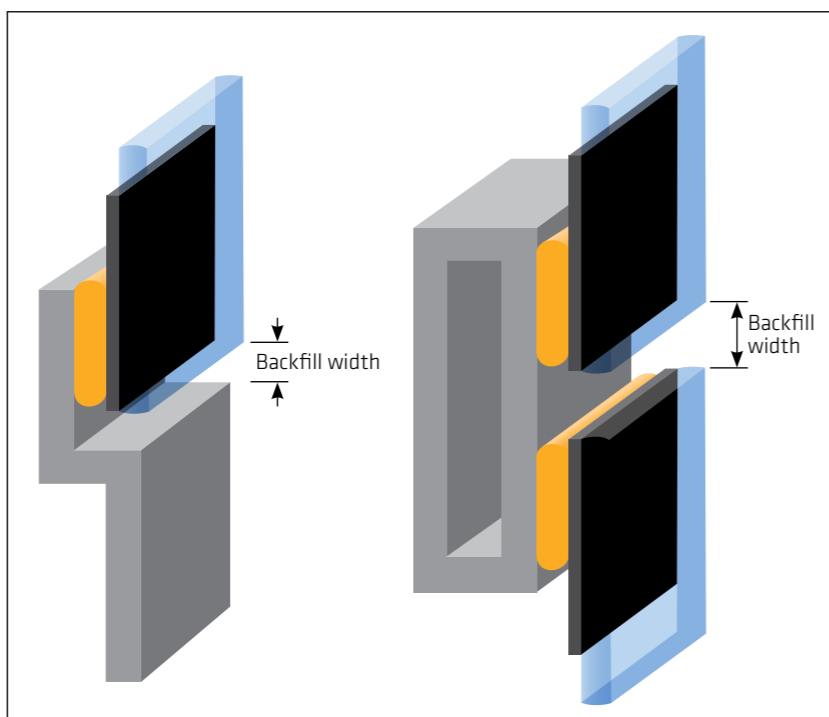

Fig. 97 The definition of backfill width

	BONDING	SEALING / BACKFILL
MINERAL GLAZING (SINGLE GLAZING)	Sikaflex®-296	Sikaflex®-296
MINERAL GLAZING (DOUBLE GLAZING)	Sikaflex®-296	Sikasil® WS-605 S
ORGANIC GLAZING	Sikaflex®-295 UV	Sikaflex®-295 UV
MINERAL GLAZING (INSULATING)	Sikaflex®-296	Sikaflex®-605 S
MINERAL GLAZING (LAMINATING)	Sikaflex®-296	Sikaflex®-296



BONDING AND SEALING ORGANIC WINDOWS

APPLICATION DESCRIPTION

Most of the organic glazing materials used in boat building are clear acrylic sheet (PMMA).

Plastic glazing products have a high coefficient of thermal expansion. In general, incorrectly installed plastic glazing panels are prone to environmental stress cracking (ESC). This can be aggravated by the use of the wrong adhesives or wrong dimensioned adhesive / sealant.

Plastic glazing products have a higher coefficient of thermal expansion than conventional glass.

Therefore, when designing glazing installations, an expansion gap of at least 8 mm all round the periphery must be incorporated between the window rebate and the plastic glazing panel to accommodate thermal movement. In case of additional mechanical fixations any clearance holes for fixing screws must be drilled oversize; slightly larger than the diameter of the screw shank. See also plastic manufacturer recommendations.

To minimise the risk of environmental stress cracking, flat sheets of plastic glazing material should be installed completely flat; they should not be forced to take up a curvature by the use of mechanical fastenings.

When the design calls for curved glazing panels, these should be prefabricated to order and properly tempered by a specialist supplier to ensure installation with no remaining stresses.

As many varieties of organic window exist, it is recommended to ensure that the specific grade selected is suitable for use with Sikaflex®-295 UV. Please note that the extruded type of organic glazing (XT) exhibits a higher tendency to environmental stress cracking than the cast type (GS).

Please contact your local Sika company for technical advice.

PROCEDURE FOR BONDING AND SEALING WITH Sikaflex®-295 UV ORGANIC WINDOWS

BONDLINE CONFIGURATION

Organic windows have a high thermal movement which creates stress in the bond line. Additionally dynamic stress due to the boat movement and the wind load have to be taken in consideration.

The following graphs are a result of theoretical and practical experience, considering all parameters of a boat under the conditions to which a window is subjected.

Basis of calculation are substrates MMA/GFK, wind load 2 kN/m², ΔT = 30° C

ADHESIVE WIDTH (BITE)

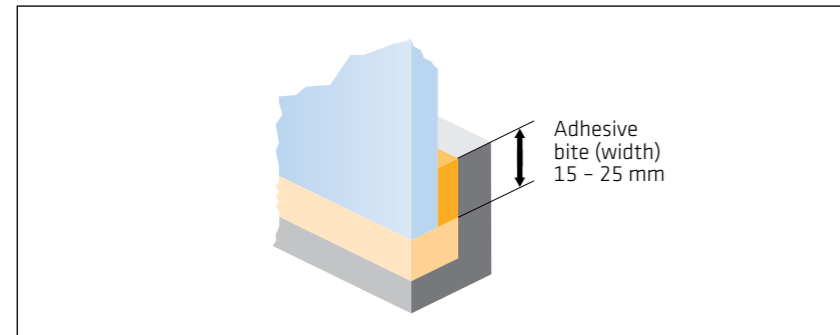

JOINT THICKNESS

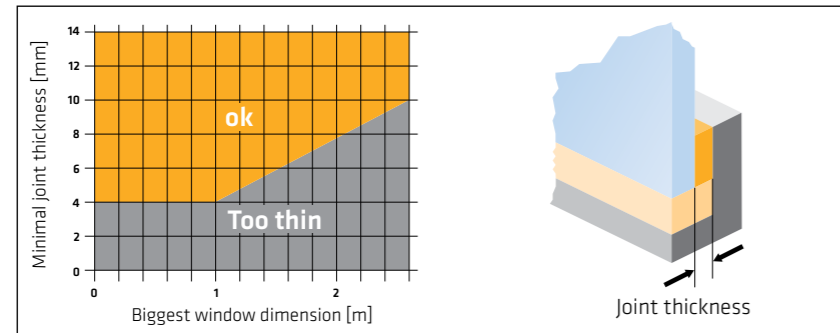

JOINT WIDTH

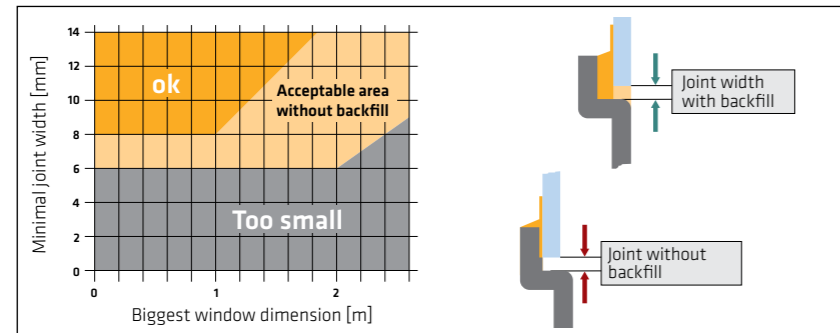

Note: For important projects consult Corporate Technical Service Sika Industry

SUBSTRATE PREPARATION

GRP FRAME

- Lightly abrade the gel coat of the contact area with a very fine sanding pad
- Remove the dust with a vacuum cleaner
- Mask off any areas that need it
- Pre-treat the substrate with Sika® Aktivator-205, using a clean, lint-free rag or paper towel. Change the rag frequently!
- Flash-off: 10 minutes (min) to 2 hours (max)
- Apply a thin, continuous coat of Sika® MultiPrimer Marine, using a clean brush or felt applicator
- Drying time: 30 minutes (min) to 24 hours (max)

ALUMINUM FRAME

- Mask off any areas that need it
- Lightly abrade the contact area with a fine sand pad
- Remove the dust with a vacuum cleaner
- Pre-treat with Sika® Aktivator-205, using a clean, lint-free rag or paper towel. Change the rag frequently!
- Flash-off: 10 minutes (min) to 2 hours (max)
- Apply a thin, continuous coat of Sika® MultiPrimer Marine, using a clean brush or felt applicator
- Drying time: 30 minutes (min) to 24 hours (max)

ALUMINUM OR TIMBER FRAME COATED WITH TWO-PART LACQUER

- Mask off any areas that need it
- Pre-treat the substrate with Sika® Aktivator-100, using a clean, lint-free rag or paper towel. Change the rag frequently!
- Flash-off: 10 minutes (min) to 2 hours (max)

IMPORTANT:
For the preparation of other substrates, please refer to the Pre-Treatment Chart for Sika Marine Applications or contact the local Technical Service Sika Industry

PMMA / PC GLAZING PANELS

- If required, apply an acryl paint or a profile opaque to cover the bond line in accordance with the Sika recommendations.
- Abrade the bond area with abrasive paper or very fine abrasive pad. Abrade the bonding periphery with 80 grit sand-paper if the organic glazing panel has a scratch proof coating (example Margard)
- Remove the dust with a vacuum cleaner
- Mask off any areas that need it
- Apply a continuous coat of Sika® Primer-209 D, using a clean brush or felt applicator
- Drying time: 30 minutes (min) to 24 hours (max)

BOND LINE PROTECTION

As with conventional glass, plastic glazing panels generally do not protect the adhesive face from damage by UV radiation. Therefore, the bond line must be protected from direct sunlight using one of the methods recommended.

- External cover strip of appropriate dimensions
- Internal sieve printing acrylic paint (contact Technical Service Sika Industry for appropriated types)

The use of black Primer Sika® Primer-209 D as a sole UV-protection is only permitted in case of a low UV-transmission of the organic glass (UV-transmission < 0,5%)

APPLICATION OF Sikaflex®-295 UV ADHESIVE

- Place spacers in position. Depending on the size of the glazing panel, the thickness of the spacer should be chosen accordingly (see page 20). Shore A hardness of the spacer approximately 30 or less
- Avoid interruption of the bead by the spacers
- Apply Sikaflex®-295 UV to the frame rebate or glazing panel using a triangular nozzle with a bead width of at least 10 mm
- Assemble all components within 20 minutes of applying the adhesive
- To prevent slip down of vertical glazing panels, distance blocks (wood or plastic) must be placed in the lower rebate during installation. After curing, these must be removed. The backfill gap must be at least 8 mm (see page 20)
- Fastening aids can be removed after 24 hours. After this time, the expansion gap between glazing panel and the backfill gap should be filled and completely sealed with Sikaflex®-295 UV. This sealant joint can be tooled to a smooth finish using Sika® Tooling Agent N. This must be carried out before skinning of the sealant
- After tooling remove any masking tape before the adhesive skins over
- Uncured Sika adhesives or sealants may be removed with Sika® Remover-208

WINDOW EDGE SEALING/ BACKFILLING

Commonly, the edge of the window will be cosmetically finished with Sikaflex®-295 UV. The preparation of the surfaces must be identical to that used for bonding. Edge sealing ensures both the prevention of standing water on or near the bond and helps cosmetically finish the window. Fill up the joint completely, ensuring there is no space between the adhesive bead and the joint. The diagram on page 72 illustrates the required dimensioning of the back-fill gap for plastic window panels using Sikaflex®-295 UV.

IMPORTANT:
Always refer to the current Sika Product Datasheet and Safety Datasheet obtainable through your local Sika company

SIKA RULE
 $O = 2 \times D$
Example:
If D = 8 mm, the overlap should be at least 16 mm

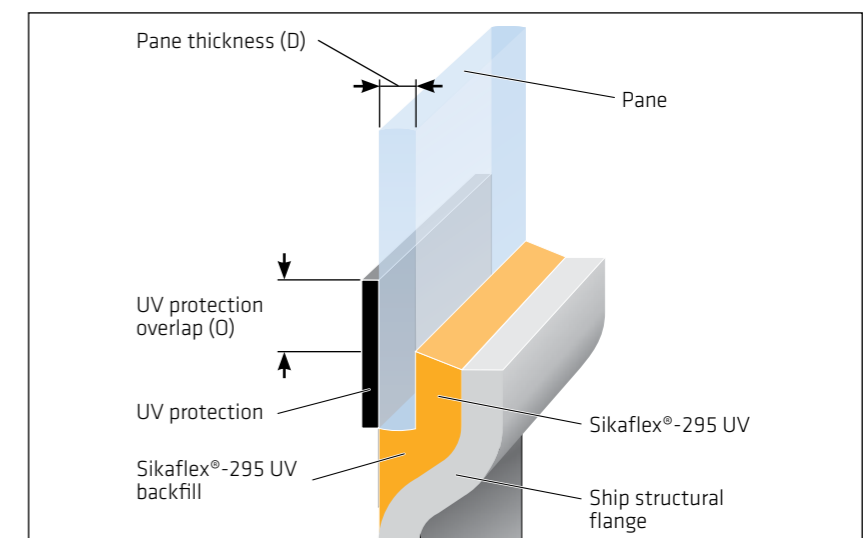

Fig. 98 Bonding a decorative panel vertically



BONDING AND SEALING MINERAL GLAZING

APPLICATION DESCRIPTION

The direct mineral glazing into frames or directly into the hull or deck, requires a full understanding of all the important principles involved.

It is essential that the glass meets all the demands and standards required for the intended application, such as IMO resolutions or other regulations as laid down by the classification societies.

In case of self cleaning glass we ask you to consult the Corporate Technical Service Sika Industry.

The adhesive bond line must be protected against UV radiation.

This may be achieved using several materials and methods:

- Using a black, ceramic coated border with a light transmission of less than 0.01%.

IMPORTANT:
Local and international rules for maritime constructions and appropriate legislation must always be observed.

BONDING AND SEALING MINERAL GLASS WITH Sikaflex®-296

ADHESIVE AND SEALANT DIMENSIONING

The dimensioning of the adhesive and the joint geometry must be carried out in accordance with Sika's basic rules of calculation. If deck movement is negligible the following dimensions are recommended.

IMPORTANT:
At all times recommendations from classification societies must be respected

Basis of calculation substrate aluminum-glass, wind load 2,4 kN/m², ΔT = 40° C

DETERMINATION OF THE ADHESIVE WIDTH (BITE)

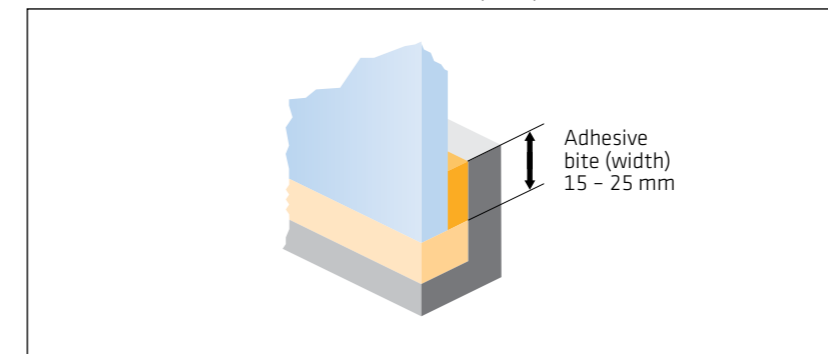

ADHESIVE THICKNESS

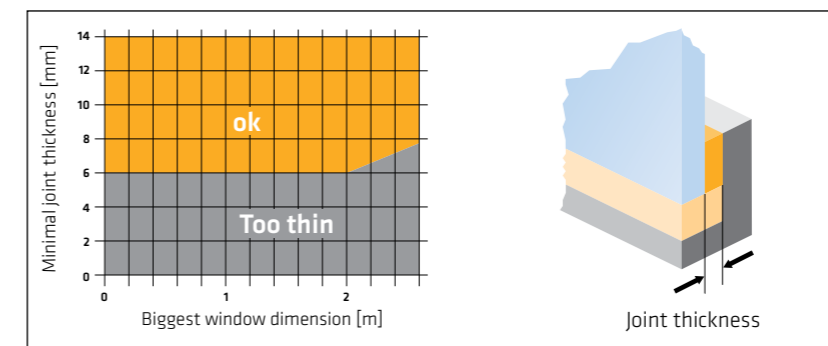

JOINT WIDTH

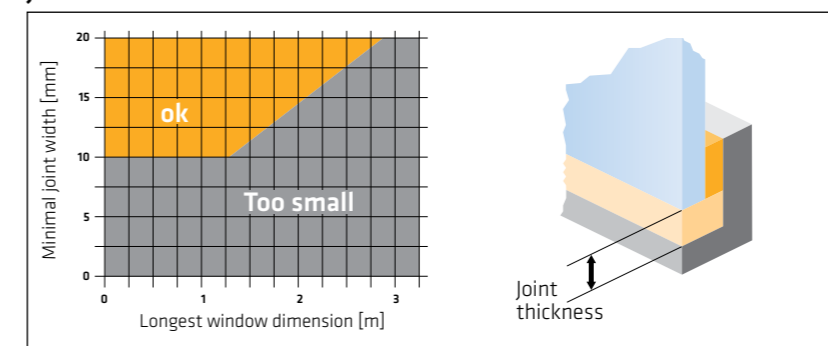

Note: For insulating glass or important projects consult Corporate Technical Service

SUBSTRATE PREPARATION

GRP FRAME

- Lightly abrade the gel coat of the contact area with a very fine sanding pad
- Remove the dust with a vacuum cleaner
- Mask off any areas that need it
- Pre-treat the substrate with Sika® Aktivator-205, using a clean, lint-free rag or paper towel. Change the rag frequently!
- Flash-off: 10 minutes (min) to 2 hours (max)
- Apply a thin, continuous coat of Sika® MultiPrimer Marine, using a clean brush or felt applicator
- Drying time: 30 minutes (min) to 24 hours (max)

For the preparation of other types of frames, please refer for the Pre-Treatment Chart for marine application.





GLASS WITH EXTERNAL UV PROTECTION OR WITH BLACK CERAMIC BORDER (TRANSMISSION < 0.01%)





- Pre-treat the substrate with Sika® Aktivator-100, using a clean, lint-free rag or paper towel. Change the rag frequently!
- Flash-off: 10 minutes (min) to 2 hours (max)

GLASS WITH BLACK CERAMIC GLASS BORDER (TRANSMISSION > 0.01% VISIBLE LIGHT)

- Pre-treat the substrate with Sika® Aktivator-100, using a clean, lint-free rag or paper towel. Change the rag frequently!
- Flash-off: 10 minutes (min) to 2 hours (max)
- Apply a thin, continuous coat of Sika® Primer-206 G+P, using a clean brush or felt applicator
- Drying time: 30 minutes (min) to 24 hours (max)

APPLICATION OF Sikaflex®-296 ADHESIVE

-  Place spacers in position. Depending on the size of the glazing panel, the thickness of the spacer should be chosen accordingly. Shore A hardness of the spacer approximately 40 or less
-  Avoid interruption of the bead by the spacers
-  Apply Sikaflex®-296 to the frame rebate or glazing panel using a triangular nozzle with a bead width of at least 10 mm
-  Assemble all components within 20 minutes of applying the adhesive

-  To prevent slip down of vertical glazing panels, distance blocks (wood or plastic) must be placed in the lower rebate during installation. After curing, these must be removed. The rebate gap must be at least 10 mm (see page 20)
-  Clamps and other fastening aids can be removed after 24 hours.
-  After this time, the expansion gap between glazing panel and the rebate should be filled and sealed with Sikaflex®-296. This sealant joint can be tooled to a smooth finish using Sika® Tooling Agent N. This must be carried out before skinning of the sealant
-  Tooling



-  After tooling remove any masking tape before the adhesive skins over
-  Uncured Sika adhesives or sealants can be removed with Sika® Remover-208



Fig. 99 Pre-treatment of the ceramic ink area with Sika® Aktivator-100



Fig. 100 Adhesive is applied to the window frame



Fig. 101 The window is fitted



FLYBRIDGE BONDING

APPLICATION DESCRIPTION

Many modern motor yachts have flybridges. Conventional fixing methods such as mechanical fixings or rigid adhesives have concentrations of peak stresses which lead to breaching of the substrate allowing access to moisture.

Bonding of flybridges using flexible adhesive systems evens the distribution of stresses and optimises resistance to impact and fatigue effects.

In service, flybridges are subjected to substantial stress on the joints at high speeds. The main reason that makes Sikaflex®-292i perfect for this application is the high modulus characteristic that ensure the integrity of the joint under stress.

A perfect cosmetic finish is obtained with the weather resistance Sikaflex®-295 UV in white colour.

FLYBRIDGE BONDING PROCEDURE

PREPARING THE SUBSTRATE GRP











-  208 Heavily soiled surfaces should first be cleaned off with a pure solvent, like Sika® Remover-208, to remove the worst of the soiling
-  Lightly abrade the contact area with a very fine sanding pad
-  Remove the dust with a vacuum cleaner
-  SA 205 Pre-treat the substrate with Sika® Aktivator-205, using a clean, lint-free rag or a paper towel. Change the rag frequently!
-  Flash-off: 10 minutes (min) to 2 hours (max)
-  SMM Apply a thin, continuous coat of Sika® MultiPrimer Marine, using a clean brush or a felt applicator
-  Drying time: 30 minutes (min) to 24 hours (max)





Fig. 102 Sealing with Sikaflex®-295 UV

APPLICATION OF Sikaflex®-292i ADHESIVE

-  Place 3 mm deep elastic spacers, of about 50 Shore A hardness, into position
-  292i Apply Sikaflex®-292i in an appropriate profile around the entire periphery of the flybridge. An additional bead may be required for heavier loads
-  Assemble the components within 20 minutes of applying adhesive
-  Apply pressure with clamps or other fastening aids to compress the adhesive to the height of the spacers



-  208 Uncured Sika adhesives or sealants should be removed with Sika® Remover-208
-  295 UV For open joints, cover Sikaflex®-292i with a layer of Sikaflex®-295 UV
-  Clamps and other fastening aids can be removed after 12 hours. Full service strength is attained after about 7 days

IMPORTANT: Always refer to the current Sika Product Datasheet and Safety Datasheet obtainable through your local Sika company



DECK AND KEEL TO HULL BONDING

APPLICATION DESCRIPTION

Arguably the most crucial joint on the vessel is that between the deck and the hull where Sika's resilient, one-component polyurethane adhesives have many benefits to the designer and boat builder alike.

The naval architect can be confident that a deck and a hull that have been built separately of differing materials can be brought together to form a single unit that is both strong and durable. The tolerances in alignment between the two parts need not be quite as close, because minor discrepancies can be taken up by the gap filling property of the adhesives.

The strength of the adhesives makes mechanical fixings redundant and the resilience absorbs much of the stresses and strains from temperature changes, impact shocks and torsion forces.

All of these factors reduce the design and source costs of the build and remove many design obstacles.

To the boat builder, the assembly techniques are simplified and streamlined.

Applying an adhesive around the joint between deck and hull is far quicker, simpler and easier than laborious GRP laminated joints.

And providing the Sika guidelines are followed ensures a reliable watertight joint, as is not the case with taping methods.

With no mechanical fixings, there is no need to drill holes in the joint area, no need for gaskets, no need to spend the time aligning the holes and no need to insert and tighten the fixings.







For information regarding bondline dimensions, please contact Sika's Technical Service department, who can also provide appropriate values for FEM calculations.

Also, the critical joint between keel and hull is subjected to very high stresses when a boat is under sail and needs to be very strong if it runs aground. So it must be designed and built with great care in order to withstand these stresses.







This particular joint is prone to leaks, which identify themselves by rust streaking and staining on the keel when the boat is out of the water.

DECK TO HULL BONDING PROCEDURES WITH Sikaflex®-292i

PREPARING THE SUBSTRATE FOR ALUMINUM

 208	Heavily soiled surfaces should first be cleaned off with a pure solvent, like Sika® Remover-208, to remove the worst of the soiling
	Lightly abrade the contact area with a very fine sanding pad
	Remove the dust with a vacuum cleaner
 SA 205	Pre-treat the substrate with Sika® Aktivator-205, using a clean, lint-free rag or a paper towel. Change the rag frequently!
	Flash-off: 10 minutes (min) to 2 hours (max)
 SMM	Apply a thin, continuous coat of Sika® MultiPrimer Marine, using a clean brush or a felt applicator
	Drying time: 30 minutes (min) to 24 hours (max)

PREPARING THE SUBSTRATE FOR GRP







 208	Heavily soiled surfaces should first be cleaned off with Sika® Remover-208, to remove the worst of the soiling
	Lightly abrade the contact area with a very fine sanding pad
	Remove the dust with a vacuum cleaner
 SA 205	Pre-treat the substrate with Sika® Aktivator-205, using a clean, lint-free rag or a paper towel. Change the rag frequently!
	Flash-off: 10 minutes (min) to 2 hours (max)
 SMM	Apply a thin, continuous coat of Sika® MultiPrimer Marine, using a clean brush or a felt applicator
	Drying time: 30 minutes (min) to 24 hours (max)

OTHER SUBSTRATE

Refer to the actual Sika Pre-Treatment Chart for Marine Applications.

APPLICATION OF Sikaflex®-292i

IMPORTANT:
It is vital to check the accuracy of the fit before applying the adhesive so that the parts do not need to be separated again once they have been brought together

	Place spacers of at least 4 mm deep and about 50 shore A hardness, in position. Alternatively, these can be pressed into the adhesive once applied
 292i	Apply Sikaflex®-292i onto the entire periphery of the hull. A continuous zig-zag bead Sikaflex®-292i should be used (Fig. 103 and 104); the amount applied will depend on the width of the bond face. The adhesive bead must be carried continuously around any cut-outs or clearance holes (e.g. for deck stanchions, pipes, chain plates) to maintain the integrity of the watertight joint
	Assemble the components within 20 minutes of applying the adhesive
	Apply pressure with clamps or other fastening aids to compress the adhesive to the height of the spacers
	Clamps and other fastening aids can be removed after 24 hours. Full service strength is attained after approximately 7 days
 208	Uncured Sika® adhesives or sealants must be removed with Sika® Remover-208

IMPORTANT:
Do not use Sika® Aktivator or any other cleaning agent or solvent for cleaning purposes



Fig. 103 Hull and deck are brought together

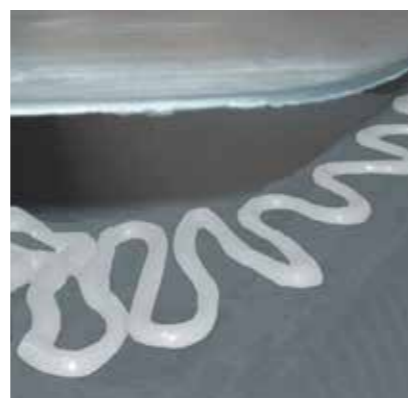





Fig. 104 A locating pin ensures perfect alignment







KEEL TO HULL BONDING

SUBSTRATE PREPARATION

ALUMINUM HULLS (PAINTED WITH 2C PAINT)

 208	Heavily soiled surfaces should first be cleaned off with Sika® Remover-208, to remove the worst of the soiling
 SA 100	Pre-treat the substrate with Sika® Aktivator-100, using a clean, lint-free rag or a paper towel. Change the rag frequently!
	Flash-off: 10 minutes (min) to 2 hours (max)

GRP HULLS

 208	Heavily soiled surfaces should first be cleaned off with Sika® Remover-208, to remove the worst of the soiling
	Lightly abrade the contact area with a very fine sanding pad
	Remove the dust with a vacuum cleaner
 SA 205	Pre-treat the substrate with Sika® Aktivator-205, using a clean, lint-free rag or a paper towel. Change the rag frequently!
	Flash-off: 10 minutes (min) to 2 hours (max)
 SMM	Apply a thin, continuous coat of Sika® MultiPrimer Marine, using a clean brush or a felt applicator
	Drying time: 30 minutes (min) to 24 hours (max)

STEEL HULLS AND KEELS, COATED WITH TWO-PART CORROSION PROTECTION PAINTS

IMPORTANT:
One-component paints are not suitable to be bonded on it. To control the quality of the paint we recommend cleaning a small part with paint thinner. If the paint resists to the solvent it is suitable and can be bonded as described in the following part. In case of the paint can be dissolved, it has to be removed and replaced by a two-component epoxy paint



 SA 100	Pre-treat the substrate with Sika® Aktivator-100, using a clean, lint-free rag or a paper towel. Change the rag frequently!
	Flash-off: 10 minutes (min) to 2 hours (max)



Fig. 105 A keel is carefully slid into position



Fig. 106 The adhesive is applied





IMPORTANT:
With lead keels, the contact area must also be given a coating with a two-part epoxy-resin based protective paint

For the preparation of other substrates, please refer to the Pre-Treatment Chart for Sika Marine Applications.



Fig. 107 The joint is tooled off and finished

APPLICATION OF Sikaflex®-292i ADHESIVE

	Place elastic spacers of about 10 mm thick and 50 Shore A hardness into position
 292i	Apply Sikaflex®-292i in sufficient quantity. Each bead must form a continuous, closed ring, with no gaps. The same applies to the beads around the bolt holes
	The keel must then be lifted into position, carefully observing the open time of Sikaflex®-292i. Then the keel bolts must be tightened as far as the spacer blocks. Any adhesive that is squeezed out of the joint can be tooled to a finish
 208	Remove Sika adhesives or sealants with Sika® Remover-208
	After three or four days, the keel bolts can be tightened to their full torque rating. The additional pressure exerted on the adhesive, gives the joint between keel and hull the required degree of torsional stiffness. When the adhesive has fully hardened, the sealed joint can be over-painted in the normal way with any good quality anti-fouling paint. The sealed joint absorbs the dynamic stresses generated in this area and forms a totally watertight bond between keel and hull

DISCLAIMER

The information, and, in particular, the recommendations relating to the application and end-use of Sika products, are given in good faith based on Sika's current knowledge and experience of the products when properly stored, handled and applied under normal conditions. In practice, the differences in materials, substrates and actual site conditions are such that no warranty in respect of merchantability or of fitness for a particular purpose, nor any liability arising out of any legal relationship whatsoever, can be inferred either from this information, or from any written recommendations, or from any other advice offered.

The proprietary rights of third parties must be observed. All orders are accepted subject to our current terms of sale and delivery. Users should always refer to the most recent issue of the Sika Product Datasheet for the product concerned, copies of which will be supplied on request.



SIKA MARINE APPLICATION GUIDE GLOSSARY OF TERMS



GLOSSARY OF TERMS

Activator

Solvent containing adhesion promoters that increase the adhesion of an adhesive on a substrate.

Adhesion

Adherence of an adhesive to a substrate.

Adhesive joint (bond-line)

Gap between two components that must be filled with adhesive.

Aging

Behaviour of the adhesive layer under the influence of time, temperature and environmental conditions.

Balanced moisture content

Moisture content of a material (specially wood) when allowed to stabilize relative to ambient levels of atmospheric temperature and air humidity.

Bonding joint

Gap between two bonding surfaces filled with adhesive.

Bondline

Contact area between adhesive and substrate.

Breaking stress

Stress required to produce failure or fracture in a material.

Clamping

Temporary securing of components in the desired position by mechanical means, with or without the application of pressure, while the adhesive is setting.

Cleaner

Chemical agent used to clean surfaces prior to bonding.

Coefficient of thermal expansion

A factor that expresses the dimensional changes in a component as a function of temperature change.

Cohesion

Inherent strength of a material.

Contact adhesive

Laminating adhesive, applied to both surfaces of the joint. Once ready, the adhesive surface is not tacky and the bonding force results only on contact of the two adhesive surfaces.

Cross-linking

Creation of a three-dimensional network through the formation of chemical bonds between molecular chains.

Curing / Setting

Setting or hardening of an adhesive due to physical or chemical reaction.

Curing conditions

Factors that influence the curing of adhesives, e.g. temperature, relative humidity.

Dew point

Temperature at which a condensation of the air humidity occurs (depending on environmental temperature and relative humidity).

Diffusion

Migration of gases or liquids through materials. The hardening process of one-component PUR and silicones is limited by the speed of diffusion of water through the hardened skin or layer of the adhesive.

Drying time

Duration required for a primer to reach a state that will safely allow the process that follows it to be started (e.g. adhesive application).

Duromer

Crosslinked, mostly unmelttable plastics.

Elastomers

Elastomers are macromolecules with an open network structure which do not undergo plastic flow even at high temperatures approaching the point of chemical decomposition, but undergo reversible elastic deformation instead.

Elongation at break

Elongation that takes place before a material fails or fractures.

ESC

Environmental stress cracking. Cracking of thermoplastics under internal or external stress and chemicals.

Final strength

Strength of an adhesive joint when the adhesive has attained full cure.

Fillers

Additives (mostly inorganic) to improve the properties of the adhesive.

Flash-off time

Duration required for a primer, solvent, cleaner or activator to reach a state that will safely allow the process that follows it to be started (e.g. adhesive application).

FEM (Finite Element Method)

Calculation using interactive analysis methods. Calculation values are available from Technical Service Sika Industry.

Fracture energy

Energy that is required to cause a material to fail or fracture.

Galvanic corrosion

Corrosion due to the electrical contact of metals with different electrochemical potential (e.g. aluminum, steel). The use of nonconductive adhesives can stop this effect.

Handling strength

Strength level development at which the bonded assembly can be handled and passed on to the next stage of processing.

Heat resistance

The ability of a material to withstand heat without altering its state as a result of exposure to a specified temperature over a fixed period of time.

Hygric movement

Movement as a result of humidity content in the material. Particularly applies to wood but also affects other materials like PA (brand name Nylon).

The values from wood depend on the type and the orientation of the grain (radial, tangential).

Joint assembly

Process of bringing the substrates together under light pressure so that the adhesive is compressed to form the adhesive bond.

Impact resistance

Resistance against abrupt forces (crash).

Modulus of elasticity

Modulus of elasticity describes the ratio of stress to strain in a rod under tension whose sides are unconstrained.

Non-sag properties

Resistance of an adhesive to collapse or slump when extruded as a bead.

One-component polyurethane adhesive

Adhesive containing isocyanate groups that cure on exposure to moisture.

Open or working time

Maximum period of time that may elapse between application of the adhesive and assembly of the joint.

Organic window

Transparent plastic such as PMMA and PC (e.g. Brand names; Plexiglas / Lexan). Thermoplastics which are prone to ESC.

Pot-life

Period of time during which multi-component adhesives can be processed after their components have been mixed. Pot-life depends on the ambient temperature and the quantity of batch mixed. It decreases with higher temperature and increased batch quantities.

Primer

A special paint coating designed to improve adhesion between adhesive and substrate. They may also have additional functions such as UV-protection of the bond line, reinforcing the substrate and some corrosion protection.

QA

Quality assurance.

Reactive adhesives

Adhesives that cure or set when exposed to heat, moisture, radiation, etc.

Resistance

Behaviour of an adhesive under changed environmental conditions.

Sag resistance (see Viscosity)**Sealant**

Substance that separates a joint from any medium to which it is exposed.

Setting

Solidification of adhesive through physical and / or chemical process.

Shear modulus

Defined as the ratio of the shear stress to the shear strain in a body that undergoes simple angular deformation.

Shelf life

Period of time that can elapse between the manufacture of an adhesive and its use, subject to storage of the product under controlled conditions.

Solvent

Organic liquid that dissolves the base materials and other soluble adhesive constituents without changing their chemistry.

Solids content

Nonvolatile portion of components.

Spacers

Elastic parts, mostly self-adhesive, used to control the thickness of the adhesive. The shore hardness of the spacer should be equal to or lower than that of the adhesive.

Substrates

The base materials to be bonded, e.g. fabric, steel, wood, GRP.

Tack-free or skinning time

Time between the application of a one-component adhesive and the formation of a skin on its surface, after which point bonding can no longer take place.

Tensile lap-shear strength

Breaking strength of the adhesive bond joining two parallel surfaces in a single lap joint when the joint is subjected to a shearing stress by applying a tensile load centrically to the two lapped substrates.

Tensile strength

Breaking stress of a material under tension.

Thermoplastic adhesive

Plastics that soften under the application of heat (e.g. PVC, PMMA, ABS).

Thermosetting resins

Closely cross-linked macromolecules that do not undergo plastic deformation, even at high temperatures (e.g. Polyester, Epoxy).

Thick-layer elastic bonding

Elastic bonding application where the thickness of the adhesive layer exceeds 3 mm.

Tie-coating

An industry specific term used to indicate a bonding coat or layer applied to a material to facilitate ready adhesion with other media.

Transmission

Ratio of the intensity of a beam of light passing through a body, related to its original intensity. Measured in the UV (organic glazing) and visible range (mineral glazing). Sika stipulates limits for primerless glass bonding.

TV-value

Maximum workplace concentration or highest admissible concentration of evaporating solvent at a workplace.

Two-part polyurethane adhesive

Adhesive formed by the addition reaction of two components; main component and hardener.

UV-radiation

High energy part of sunlight, mainly responsible for surface degradation of organic materials like paint, sealants, etc.

Viscosity

Resistance to flow exhibited by fluids or paste-like substances as a result of internal friction.

White spirit

Petroleum spirit solvent, common used for thinning and cleaning.

Wetting

Ability of liquids to disperse themselves uniformly over solid materials.

Wet bonding

Method of bonding whereby the adhesive is applied by wetting.

BUILDING TRUST

