



Maewan Adventure Base_ Ile de Rapa - Polynésie



New range of chain grips.
See page 23



New range of soft snatch blocks
See page 47



New Offshore Rescue knife
Plain black blade
See page 57



New fixed rounded pad eye
Outstanding mechanical resistance
High corrosion resistance
See page 16



New stainless steel deck fairlead
For furling line of manual furlers or flying sail
furlers with drum.
See page 63



New Trigger snap shackle
Working load 8 T
See page 19

Summary

WICHARD	p. 4 7
STAINLESS STEEL PRODUCTS	p. 8 32
RIG ADJUSTERS AND WIRE ACCESSORIES	p. 9 11
Babystay adjusters	p. 9
Backstay adjusters, accessories for babystay adjusters, foldable mast step, sail chafe protector	p. 10
Lifeline hooks	p. 11
FASTENINGS	p. 12 16
Folding pad eyes	p. 13
Toe rail pad eyes and watertight U-bolts	p. 14
Eye nuts, eye straps and eye bolts	p. 15
Fixed pad eyes	p. 16
SNAP HOOKS	p. 17 24
Snap shackles	p. 18
Trigger snap shackles	p. 19
Quick release snap shackles & opening pre feeder	p. 20
Snap hooks	p. 21
Carbine hooks, one hand sail snaps	p. 22
Mooring hooks, chain grips, rings and adjusters	p. 23 24
SWIVELS	p. 25 26
SHACKLES	p. 27 32
Standard self-locking shackles	p. 29
Captive pin shackles, key pin shackles, thimble shackles	p. 30
«HR» and Titanium shackles - Soft shackle SoftLink - Accessoires et entretien	p. 31 32
BLOCKS	p. 33 48
FRX: rings	p. 35
MXLEvo soft block, MXEvo one-piece block	p. 36 47
Stainless steel blocks - Ball bearing blocks and plain bearing blocks	p. 38 43
Roller blocks	p. 44 46
Snatch blocks	p. 47
Deck accessories	p. 48
SAFETY	p. 49 54
Gyb'Easy: boom brake	p. 50
Lyf'Safe jacklines	p. 51
Proline and Proline'R tethers	p. 52 53
Tethers : with double action safety hook and carabiner - Tethers with quick opening snap shackle	p. 54
WICHARD KNIVES: Offshore -Rescue - Aquaterra	p. 55 59
SAILING ACCESSORIES	p. 60 61
SUPPLEMENTARY PRODUCTS	p. 62 65
Fortress anchors - anti torque cable	p. 62 63
PEGUET quick links	p. 64
TECHNICAL INFORMATION	p. 65 66
CONTACT	p. 67

It all started in 1919 - or maybe a bit earlier!

Before becoming a foundry and taking on the name Wichard, the historic factory was initially called the Croix de Fer (or Iron Cross) factory and was actually a paper mill.

The mill owed its name to a forged Iron Cross that was known as 'the paper mill's cross'.

In 1887, the owner at the time sold his establishment to Messrs Bizet and Pradel, who converted it into a cutlery factory.

In 1919, Antoine Bizet formed a partnership with a certain Henri Wichard, setting up a company that would "specialise in the production of everything for the cutlery

industry and locksmithing using processes such as cutting and stamping".

The latter, a blacksmith by trade from a long line of master smiths from eastern France, added his expertise.

Henri Wichard & Co was born.

Up until the end of the Second World War, Wichard forged knife tangs and blades, scissors and components used in the hunting rifles produced by the St Etienne arms factory.



1887: The Croix de Fer paper mill becomes a cutlery factory owned by Bizet and Pradel.



The factory is converted and expanded, including the installation of blade sharpeners, polishers and handle makers.



Antoine Bizet forms a partnership with Henri Wichard - The company Henri Wichard & Co is founded at the Croix de Fer factory



*x d'aiguillat, donner la
dépouille normale vis 3 cotés
soit 1/10 par millimètre.*

*N et N' parties arrondies de la
branche*

*I et V parties cylindriques en bas
de l'arroust de la branche.*

H.W



Range of shackles - developed alongside Bernard Moitessier



1st catalogue for marine hardware - development of the 2480 snap hook

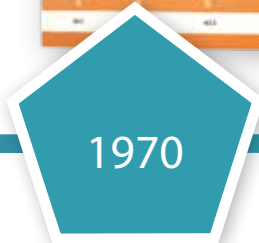
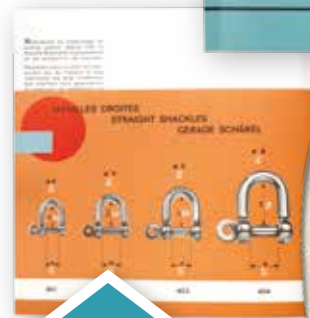

2nd production site
An automatic forging line is put in place.
Development of deckfitting products and the titanium forge (medical)

Products: Snap hooks

Double safety snap hooks given 1st prize at the Dame Award-Safety tethers

1984: Nouvel Economiste - Europe 1: Award for design: Quick release snap shackle

Folding pad eyes

Wichard blocks are added to the catalogue

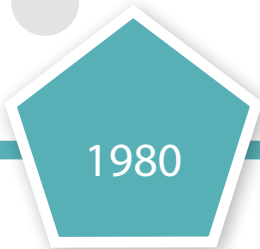

Development of international network
Products: One hand sail snaps, eye bolts, saddles, lifeline hooks, folding pad eyes

The American subsidiary is created: Wichard inc
Takeover of Maillard (plastic injection), who would produce Wichard blocks
Products: turnbuckles, U-bolts, watertight U-bolts, double folding pad eyes, Wichard blocks, safety tethers



Wichard is taken over by a group of private shareholders -
The Australian subsidiary Wichard Pacific is founded, takeover of Forginox, a cutlery factory in Thiers.

All activity is brought together at one single site within an industrial estate. The introduction of a high-speed machining platform for the development of production machinery, the deployment of a new forging press, the installation of a 5-axe machining centre

Products: trigger snap shackles, roller blocks, boom brake, jacklines



2010

2013

2015

2019

Proline: new range of safety tethers

Products : Proline safety tethers Offshore and Aquaterra knife ranges, maintenance products



Offshore & Aquaterra knife ranges

Wichard celebrated its 100th anniversary



The forge - our trade yesterday, our trade tomorrow

Produced in France since 1919, the trade of the blacksmith has undergone significant changes, but it remains a trade for men and enthusiasts. At Wichard, we manage the entire process, from the production of equipment and stamping right through to packaging. Our expertise is passed on throughout the company and we are proud to have kept all of our manufacturing in France.



Why choose a Wichard forged product?



Our manufacturing process: -always manual, always meticulous

There are a significant number of steps involved in the development of each forged Wichard product. For our iconic 2480 snap hook, for example, 21 steps are involved, with the majority of these carried out by a Wichard employee.

Expertise handed down from generation to generation and innovative development.

Although our expertise has been handed down from one generation to the next, we design and manufacture all of our new products in an innovative and contemporary way.

Our design department innovates by using modern methods for development and prototyping.

At the same time, we work to ensure both our expertise and our production methods evolve in order to keep pace with developments in the yachting market.

The main production steps for forged products are as follows:

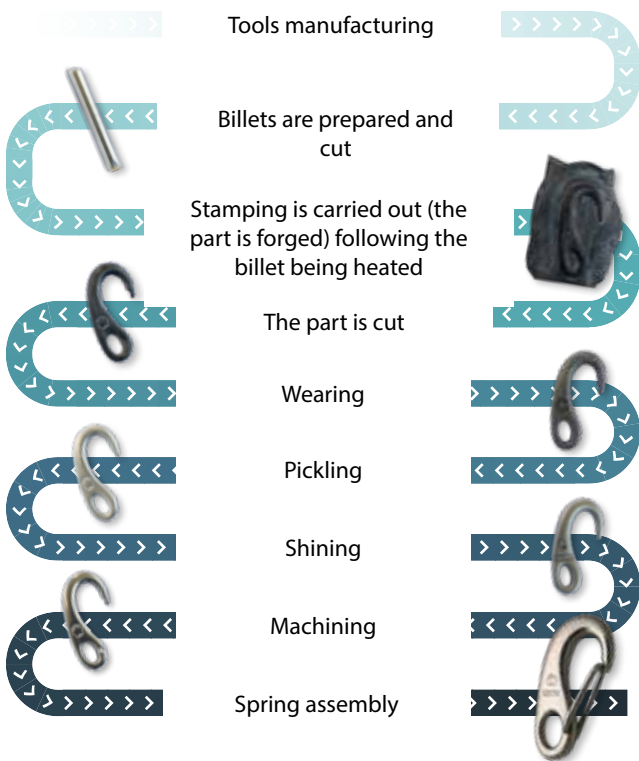

Wichard quality is what matters most

Our shared goal is to offer our clients products that provide the very best when it comes to safety and quality. In order to ensure this, we deploy a quality control procedure for each batch of manufactured components:

Test/traction bench for mechanical resistance



Dimensional checks

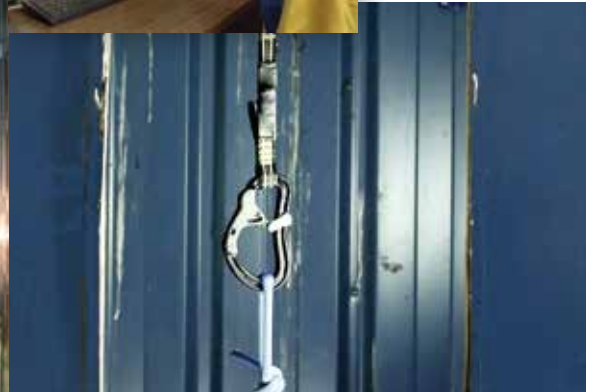

Drop tests for our safety tethers



During the 2000s, following a decision taken by upper management and private shareholders, Wichard became a group incorporating a number of different trades, with more than 250 employees in France in 2019. Through these

various acquisitions, the Wichard Group is aiming to become a major player in yachting, particularly through the group's two subsidiaries in the USA and in Australia.

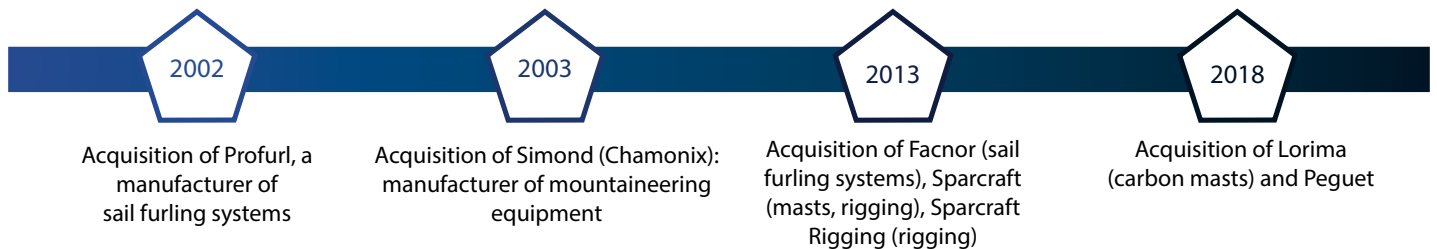

Our brands



Thiers
Forged marine hardware,
sail furling systems



St Vaast la Hougue
- La Rochelle
Aluminium masts



St Malo
Injection of plastic
components



St Vaast la Hougue
Sail furling
systems



Lorient
Carbon masts



peguet.fr
Annemasse
Quick links

Protecting the environment



At Wichard, we don't simply pay lip service to environmental protection. When manufacturing our knives, we do everything practical to contribute to Protecting nature on a daily basis:

Respect all applicable environmental requirements

Take active measures to prevent pollution.

Design products that preserve environment and are recyclable

Reducing the manufacturing of sub-standard items, especially waste.

- Producing no more than is required.
- Minimize the environmental impact of its sites by:
 - limiting the consumption of raw materials and energy;
 - using clean manufacturing processes;
 - avoiding the discharge of any material that may pollute the soil, air or waterways and treating its waste effectively.
- Involve its partners and collaborators in its improvement process.



Stainless steel products



Wichard offers a complete range of stainless steel products including:

- Babystay adjusters, backstay adjusters.
- Wire accessories: lifeline hooks.
- Fastenings: folding pad eyes, watertight U-bolts.
- Eye straps, eye nuts and eye bolts.
- Snap hooks and swivels.
- Shackles.

Babystay adjusters



For fitting a jib, setting up a genoa or a solent jib... Both for safety and performance reasons, fitting a removable inner forestay is strongly recommended when there is a roller furling system. Wichard offers a whole range of babystay adjusters. The table below will allow you to determine the best suitable product for your boat.

+ BENEFITS

- Large range of babystay adjusters
- Available with wheel, handle or ratchet
- Ergonomic and comfortable to use
- Easy to install and dismantle
- Forged body and snap hook
- Resistant to high loads
- Perfect for setting a flying sail (solent jib or storm jib)
- Optimizes yacht performance
- Long travel model available

N°	Part #	Length pin to pin closed / open mm	Toggle length x width mm	Ø pin mm	Handling Kg	W.L. Kg	B.L. Kg	Ø stud mm	For wire Ø mm	Weight Kg
WITH WHEEL (DELIVERED WITH SHACKLE PART # 1206)										
1	5546	250 / 310	15 x 20	12	1200	2800	5300	12	5/6/7	1.090
WITH HANDLE										
2	5554	310 / 450	10 x 10	8	800	960	2400	8	4/5	0.802
3	5556	450 / 510	15 x 20	12	1200	2800	5100	12	5/6/7	1.268
4	5566	370 / 540	15 x 20	12	1200	2800	5000	12	5/6/7	1.390
WITH RATCHET										
5	5585	360 / 520	17 x 22	12	2500	3200	6000	14	7/8/9	1.848
	5587	360 / 520	17 x 22	14	2500	3200	6700	14	7/8/9	1.856
	5588	415 / 615	18 x 25	16	2500	3200	9000	16	9/10	2.862



1



2



3



4

5

SELECTION CHART OF BABYSTAY ADJUSTERS PER SIZE OF BOAT

Length in m		6 to 7.60	7.60 to 9.00	9.00 to 10.00	10.00 to 10.70	10.70 to 11.15	11.50 to 12.00	12.00 to 13.60	13.60 to 14.50
Length in ft		20 to 25	25 to 30	30 to 33	33 to 35	35 to 38	38 to 40	40 to 45	45 to 48
Head stay	Removable stay								
5 mm	4 mm	5554	5554						
6 mm	5 mm	5554	5546/5556 5566	5546/5556 5566					
7 mm	6 mm	5546/5556	5556/5566	5556/5566	5566				
8 mm	7 mm	5546/5556	5566/5587 5585	5587/5585	5587/5585	5587/5585	5587/5585	5587/5585	5587/5585
9 mm	8 mm		5587/5585	5587/5585	5587/5585	5587/5585	5587/5585	5587/5585	5587/5585
10 mm	9 mm		5587/5585	5587/5585	5587/5585	5587/5585	5587/5588	5588	5588
12 mm	10 mm			5588	5588	5588	5588	5588	5588

These indications are not contractual, as each boat is different, we recommend checking with a professional.

WL: working load - BL: breaking load

Accessories for babystay attachment

N°	Part #	Description	Weight kg
1	9150	Babystay tang , to be fitted to the mast	0.306
2	6564	Double folding pad eye dia 6 (see page 13)	0.126
	6565	Double folding pad eye dia 8 (see page 13)	0.252
	6566	Double folding pad eye dia 10 (see page 13)	0.494
3	9204	Eye strap, used as a backing plate for double pad eye part #6564 & 6565 (see page 13)	0.038
	9205	Eye strap, used as a backing plate for double pad eye part #6566 (see page 13)	0.075
4	6435	Threaded eye hook for tensioning. Breaking load 1000 kg (small yachts). Length: 450 mm - M10	0.254

Wichard offers a comprehensive range of fixing points for babystay attachment. Double pad eye allows a single attachment point for both the babystay pelican adjuster and the jib tack point, fits all sizes of adjusters.



Backstay adjusters

N°	Part #	Length pin to pin Closed/open mm	Togglelength x width mm	Ø pin mm	Handling mm	W.L. Kg	B.L. Kg	Ø Stud mm	For wire Ø mm	Weight Kg	
WITH WHEEL											
5	5526	350 / 520	15 x 20	12	1200	2800	5300	12	5/6/7	1.128	
WITH HANDLE											
6	5536	350 / 520	15 x 20	12	1200	2800	5300	12	5/6/7	1.306	
WITH RATCHET											
7	5565	440 / 660	17 x 22	12	2500	3200	5000	14	7/8/9	2.052	
	5567	440 / 660	17 x 22	14	2500	4400	6700	14	7/8/9	2.088	
	5568	505 / 755	18 x 25	16	2500	5600	9000	16	9/10	3.264	

+ BENEFITS

- Available with wheel, handle or ratchet
- Ergonomic and comfortable to use
- Optimizes rigging performance
- Compact size
- Forged body
- Resistant to high loads



5



6



7

Foldable mast step

+ BENEFITS

- Quick and easy to install without need to modify the base
- Locks in place for maximum security
- The notched surface and end piece ensure a strong, stable support for your feet and reduce risk of slipping
- UV resistant, corrosion-free
- Lightweight: extra weight in the upper sections.
- SWL: 140 Kg
- Colour: grey

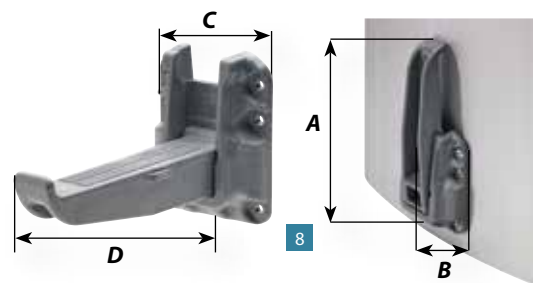

N°	Part #	A mm	B mm	C mm	D mm	Weight Kg
FOLDABLE MAST STEP						
8	5100	173	36	70	154	0,190

Sail chafe protector

SAIL CHAFE PROTECTOR

- 9 4107 This two part ring which is suitable for clipping on to 6 to 10 mm diameter wires, protects sails and facilitates manoeuvring whilst minimising snagging risks; Overall diameter 70 mm

WL: working load - BL: breaking load



9



Lifeline hooks



Automatic locking

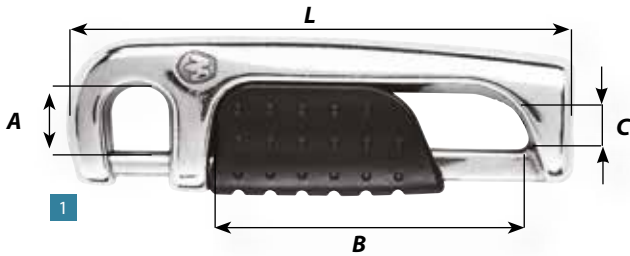

N°	Part #	Length mm (L)	A mm	B mm	C mm	W.L. Kg	B.L. Kg	Weight Kg
AUTOMATIC LOCKING LIFELINE HOOK								
1	2834	91	11	55	M6x100	640	1500	0,102
	2835	91	11	55	M8x125	640	1500	0,102

+ TECHNIQUE

- Automatic locking lifeline hook
- Only takes one hand to operate
- Forged Duplex stainless steel body - composite injection trigger (PBT) - 316L spring and piston
- Extremely strong, UV resistant and corrosion free
- Compact and lightweight
- For M6 and M8 lifelines

Standard locking

+ BENEFITS

- Registered design
- Forged in 316L stainless steel
- For closing lifelines gate
- Off-centre shape allows the wires to be tensioned easily

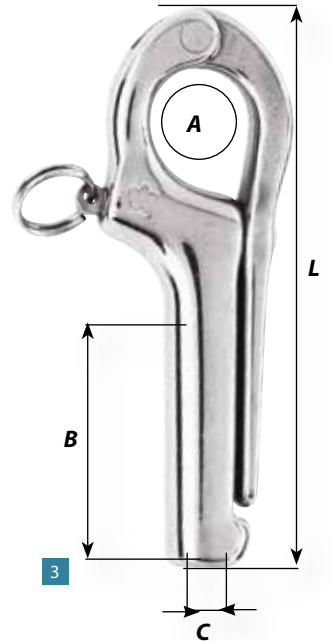

N°	Part #	Length mm	A mm	B mm	C mm	Tension mm	W.L. Kg	B.L. Kg	Weight Kg
PELICAN HOOKS «PATENTED»									
2	12836	170	20	18	M12 x 175	28	2400	6500	0.558
	12837	170	20	18	M14 x 200	28	3200	6500	0.534
3	2831	100	16	48	M8 x 125	22	640	2300	0.106

Swage studs & wire grips

N°	Part #	A mm	B mm	C mm	D mm	E mm	For wire Ø mm	Weight Kg
SWAGE STUDS (FOR PART # 2831 ET 2833)								
4	7802	7,5	40	4,3	M8 x 125	40	4	0.036
	7803	9	40	5,3	M8 x 125	48	5	0.042
	7804	11	40	6,3	M8 x 125	56	6	0.056

N°	Part #	For wire Ø mm	A mm	B mm	P mm (min/max)	Weight Kg
WIRE GRIPS						
5	7304	3-5	5		M4 x 70	2/9
	7306	5-6	7		M5 x 90	4/13
	7308	7-8	9		M6 x 100	6/17
	7310	10	11		M8 x 125	8/21
	7312	12	13		M8 x 125	10/26

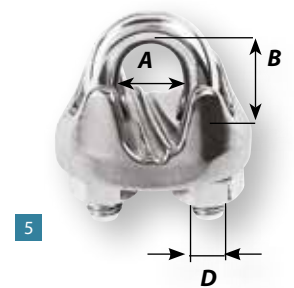
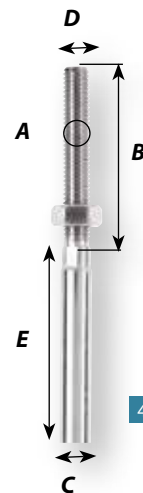

WL: working load - BL: breaking load



Fastenings



The Wichard range intended for safety fixing of deck and rigging components, provides an elegant and effective solution.

This range has applications that extend beyond the maritime sector, and they are also used in the industrial field, as well as for architectural purposes and interior decorating.

Wichard offers a wide range of padeyes:

- Folding padeyes in stainless steel or titanium.
- Toe rail padeyes.
- U-bolts.
- Watertight U-bolts.

Folding pad eyes

+ BENEFITS

- Made in France
- Hot forged
- Available in single and double models
- Available in 316L/17.4 Ph s/s or Titanium
- Outstanding working loads in all position
- Compact, can be folded
- Silicon pad to reduce noise and vibrations
- Aesthetic
- Multi-use: fastening, shrouds, blocks, jackstays etc...



Wichard folding pad eyes comply with ISO 15085 and are highly recommended for lifeline and tether fastening points

Wichard padeyes: Choose the original!

Only Wichard padeyes are completely forged. They are 100% safe, highly resistant to corrosion and their design is suitable for all types of boats.

N°	Part #	Ø D mm	A mm	B mm	C mm	Ø d mm	E mm	W.L. Kg	B.L. Kg	Weight Kg
UNIVERSAL FOLDING PAD EYE - INCL. SILICON PAD - ISO 15085										
1	6684	6	40	23,4	min 15	7	40	750	1600	0.056

N°	Part #	Ø D mm	A mm	B mm	C mm	Ø d mm	D mm	E mm	F mm	W.L. Kg	B.L. Kg	Weight Kg
FOLDING PAD EYE - INCL. SILICON PAD - ISO 15085												
2	6604	6	45	27	15	6	44	41	27	1440	3000	0.078
2	6605	8	57	35	18	8	59	51	35	2400	5000	0.165
2	6606	10	75	45	25	10	80	68	45	4080	9000	0.355

N°	Part #	Ø D mm	A mm	B mm	C mm	Ø d mm	E mm	W.L. Kg	B.L. Kg	Weight Kg
TITANIUM FOLDING PAD EYE «PATENTED»										
2	56504	6	45	27	14	6,4	40	1600	3000	0.040
2	56505	8	59	35	17	8,5	50	2720	5000	0.080
2	56506	10	75	45	23	10,5	65	4560	8500	0.174

The Wichard double folding pad eyes have been designed to attach several shrouds or a removable stay.

N°	Part #	Ø D mm	A mm	B mm	C mm	Ø d mm	E mm	F mm	W.L. Kg	B.L. Kg	Weight Kg
DOUBLE FOLDING PAD EYE											
3	6564	6	45	27	14	6,4	75	59	1440	2500	0.126
3	6565	8	59	35	17	8,5	81	59	2400	4300	0.252
3	6566	10	75	45	23	10,5	104	78	4560	9000	0.494

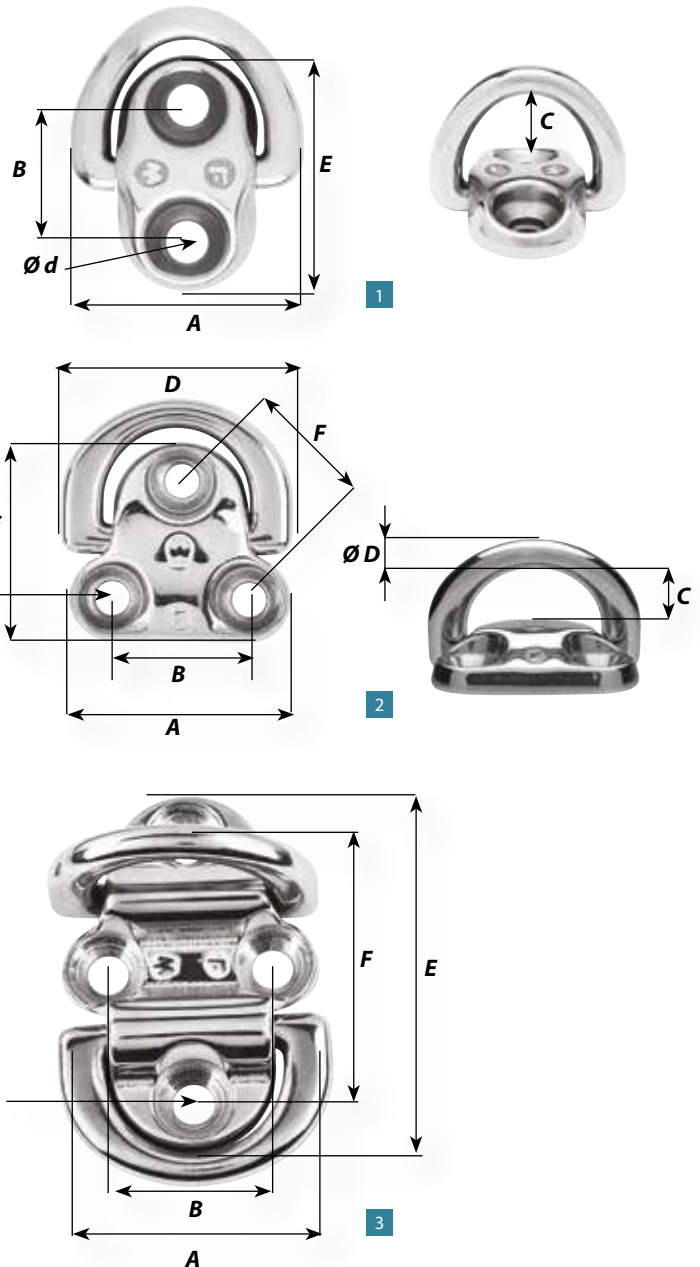

Toe rail pad eyes - U-Bolts pad eyes

Using these sliding padeyes, the toe rail can be used without any risk of damage, for a wide range of applications, such as attaching running rigging, barber hauler, boom brake, kicking strap, or mooring/fender line guide when docked.

N°	Part #	Toe rail	Ø A mini - maxi mm	H mini mm	C mini - maxi mm	D mm	W.L. Kg	B.L. Kg	Weight Kg
TOE RAIL PAD EYES «PATENTED»									
1	16613	Standard	9-13	40	2-4	14	960	3000	0186
	16614	Asymetric	9-13	40	2-5	14	960	3000	0186

N°	Part #	D mm	L mm	A mm	B mm	C mm	W.L. Kg	B.L. Kg	Max tightening torque Nm	Weight Kg
U-BOLTS										
2	6511	4	50	24	21	27	480	1000	2,3	0.022
	6512	5	60	28	24	30	640	2000	4,5	0.035
	6513	6	70	32	27	35	1280	3000	7,5	0.060
	6523	6	90	32	27	55	1280	3000	7,5	0.067
	6514	8	80	36	30	40	2400	4800	18	0.114
	6524	8	100	36	30	60	2400	4800	18	0.127
	6515	10	90	40	32	45	3600	7000	36	0.200
	6525	10	110	40	32	65	3600	7000	36	0.222
	6516	12	110	44	34	50	6400	10000	60	0.319
	6526	12	130	44	34	70	6400	10000	60	0.349

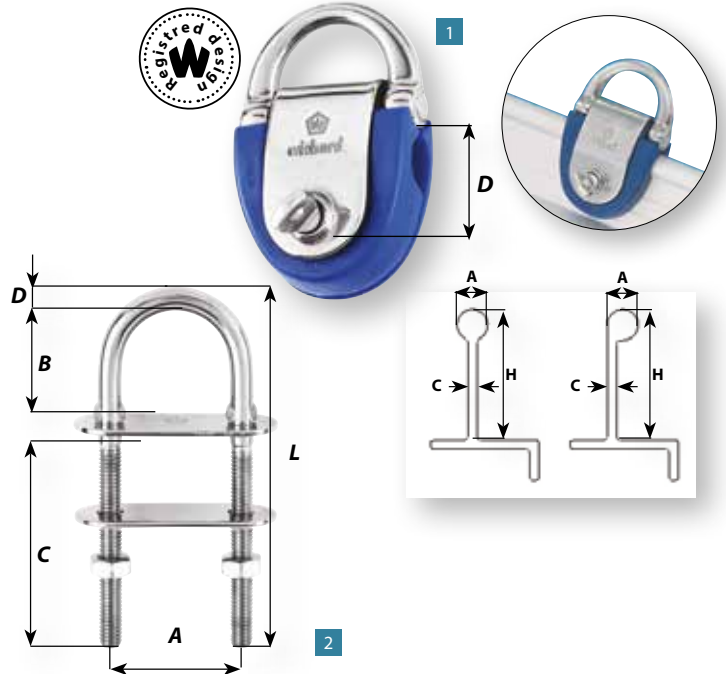

Watertight U-bolts

+ BENEFITS

- Registered design - Made in France
- Outstanding working loads
- UV-resistant rubber collar
- Complete watertightness guaranteed
- Available in black and white
- Eliminates need to install watertight seal
- Aesthetically pleasing solution
- Delivered with nuts and counterplate



N°	Part # black	Part # white	D mm	L mm	A mm	B mm	C mm	W.L. Kg	B.L. Kg	Max tightening torque Nm	Weight Kg
WATERTIGHT U-BOLTS «PATENTED»											
3	65321	65322	5	60	28	21	30	640	2000	4,5	0.035
	65331	65332	6	70	32	24	35	1280	3000	7,5	0.060
	65431	65432	6	90	32	24	55	1280	3000	7,5	0.068
	65341	65342	8	80	36	25	40	2400	4800	18	0.123
	65441	65442	8	100	36	25	60	2400	4800	18	0.136
	65351	65352	10	90	40	26	45	3600	7000	36	0.219
	65451	65452	10	110	40	26	65	3600	7000	36	0.238
	65361	65362	12	110	44	27	50	6400	10000	60	0.345
	65461	65462	12	130	44	27	70	6400	10000	60	0.375

WL: working load - BL: breaking load

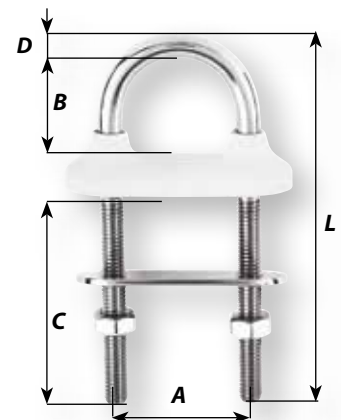

Eye straps



+ BENEFITS

- Hot forged with 316L stainless steel
- High resistance
- Round shape to prevent wear to straps, lines etc...
- Multi-use

N°	Part #	Ø D mm	A mm	B mm	E mm	B.L. Kg	Weight Kg
SADDLES							
1	9201	4	8	11	32	650	0.004
	9202	5	10	14	37,5	1800	0.009
	9203	6	12	16	45	2400	0.016
	9204	8	16	21	60	3500	0.038
	9205	10	20	26	78	7000	0.075

N°	Part #	Ø D mm	A mm	B mm	E mm	Weight Kg
WEBBING EYE STRAPS						
2	9211	4	28	5	56	0.007
	9212	5	34	10	65	0.013
	9222	5	50	12	86	0.018

N°	Part #	Ø D mm	A mm	B mm	E mm	Weight Kg
REEFING EYE STRAP						
Many purposes like reefing applications.						
3	9412	6	10	35	15	0.019

N°	Part #	Ø D mm	A mm	B mm	E mm	Weight Kg
FLAT EYE STRAP: TO TENSION MULTIHULL TRAMPOLINE						
4	9413	7	12	50	18	0.033

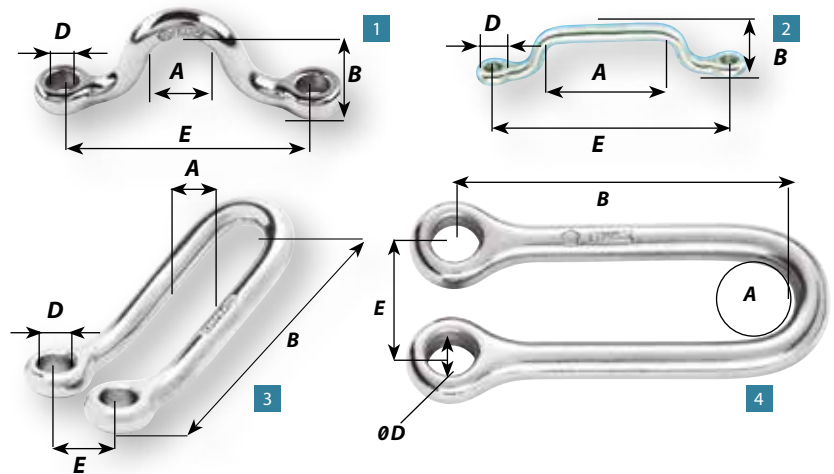

Eye nuts and eye bolts

Wichard eye nuts and eye bolts are single-piece forged components that guarantee you excellent safety standards for your fastenings. They come in a broad range of sizes, enabling you to find the solutions best suited to your circumstances. Should you wish to order large quantities with specific lengths or diameters, Wichard can also manufacture custom-made items.

N°	Part #	A mm	B mm	C mm	D mm	E mm	F mm	G mm	W.L. Kg	B.L. Kg	Max tightening torque Nm	Weight Kg
EYE BOLTS												
5	6490	M6 x 100	12	25	5	17	40	34	560	900	7,5	0.024
	6491	M6 x 100	12	25	5	17	60	54	560	900	7,5	0.027
	6492	M8 x 125	14	30	6	20	80	70	960	1500	18	0.056
	6493	M8 x 125	14	30	6	20	100	90	960	1500	18	0.061
	6495	M10 x 150	16	36	7	25	100	88	1600	2700	36	0.098
	6497	M12 x 175	18	41	8	28	120	105	2400	3500	60	0.163

N°	Part #	A mm	B mm	C mm	D mm	E mm	*B.L. Kg	Weight Kg
EYE NUTS								
6	6333	M6 x 100	13	27	6	17	1500	0.022
	6334	M8 x 125	13	27	6	17	2200	0.020
	6344	M8 x 125	17	36	8	22	3000	0.051
	6345	M10 x 150	17	36	8	22	4500	0.049
	6355	M10 x 150	22	46	10	28	4800	0.099
	6356	M12 x 175	22	46	10	28	5200	0.095
	6366	M12 x 175	27	56	12	34	7000	0.175
	6367	M14 x 200	27	56	12	34	9000	0.171
	6368	M16 x 200	27	56	12	34	10000	0.165

* The strength figures given are an indication only and change according to specification of the end fitting

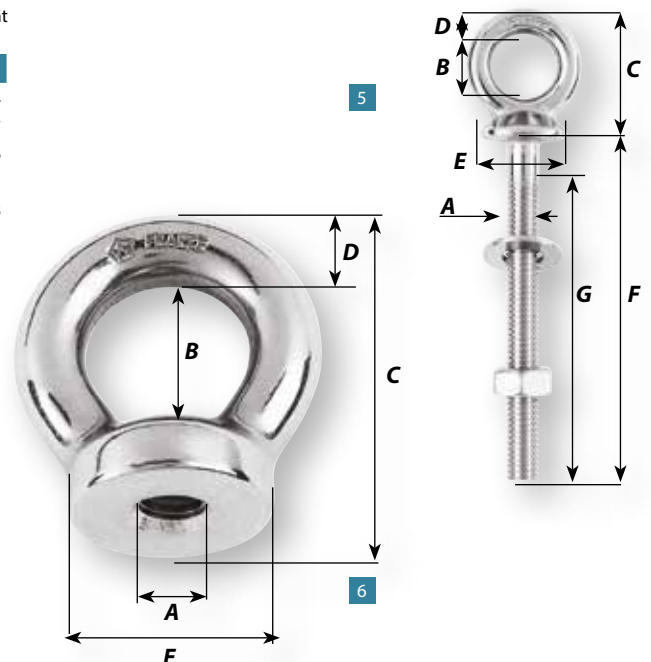

WL: working load - BL: breaking load

RANGE OF FIXED PAD EYES

+ BENEFITS

- Multi-use : mast foot blocks, reefing blocks, various fastenings
- Mechanical resistance versus corrosion resistance ratio
- Optimized dimensions
- Rounded model for ropes and webbings
- Squared model for stainless steel fastening (fork) and webbing
- 3 sizes per model
- Material : stainless steel Duplex

part #	A mm	B mm	C mm	D mm	Ø d mm	E mm	F mm	W.L.1 Kg	W.L.2 Kg	W.L.3 Kg	B.L.1 Kg	B.L.2 Kg	B.L.3 Kg	Weight Kg	
FIXED PAD EYES - ROUNDED MODEL FOR TEXTILE FASTENINGS															
1	6644	60	46	38	24	M5	14.5	19	1200	1100	1100	3200	3000	3000	0.059
2	6645	79	60	50	32	M6	18.5	22	2900	2600	2400	7800	6900	6300	0.143
3	6646	98	73	59	35	M8	22	27	4200	4200	4100	11200	11200	11000	0.250

Part #	A mm	B mm	C mm	D mm	Ø d mm	E mm	F mm	W.L.1 Kg	W.L.2 Kg	W.L.3 Kg	B.L.1 Kg	B.L.2 Kg	B.L.3 Kg	Weight Kg	
FIXED PAD EYES - SQUARED MODEL FOR STAINLESS STEEL FASTENING															
4	6654	60	46	38	24	M5	12	19	1200	1200	1100	3200	3200	3000	0.059
5	6655	79	60	50	32	M6	15.5	22	2700	2600	2400	7300	6900	6300	0.145
6	6656	98	73	59	35	M8	19.5	27	4300	4300	4100	11600	11600	11000	0.255

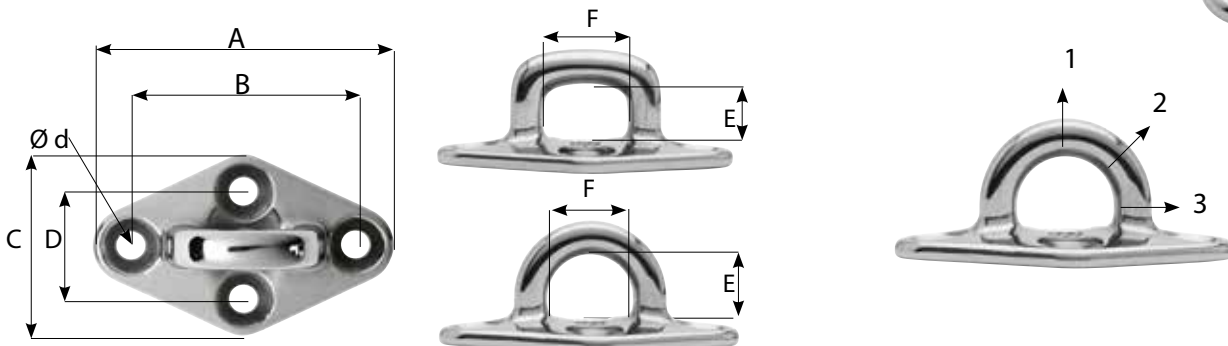

part #	Ø A mm	B mm	D mm	Ø d mm	E mm	F mm	W.L.1 Kg	W.L.2 Kg	W.L.3 Kg	B.L.1 Kg	B.L.2 Kg	B.L.3 Kg	Weight Kg	
FIXED ROUNDED PAD EYE -														
7	6635	57	27	30	M6	19	22	2300	2050	1950	4550	4100	3900	0.150

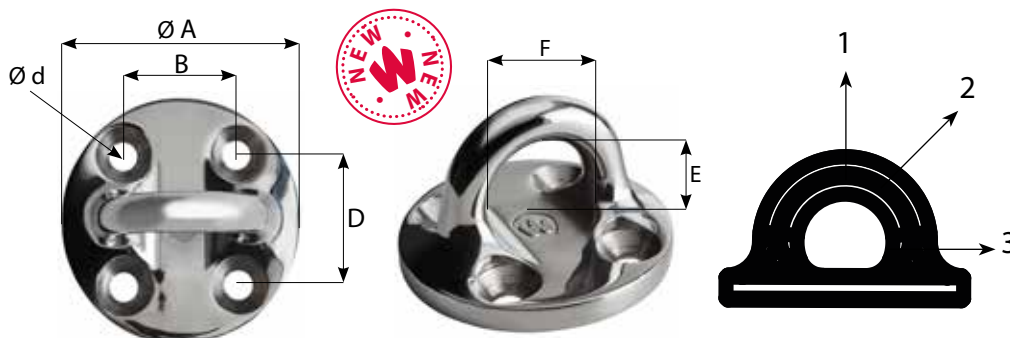

+ BENEFITS

- Multi-use : Reefing blocks, fastening point on bowsprit, fastening point for blocks.
- Outstanding mechanical resistance
- High corrosion resistance
- Fitting with M6 screws
- Material : Duplex stainless steel grade



Snap hooks



Whatever your application, you will always find the appropriate Wichard snap hook.

Wichard offers a complete range of snaps hooks:

- «HR» snap shackles.
- Trigger snap shackles.
- Quick release snap shackles.
- Snap hooks.
- Carbine hooks.
- Mooring hooks.

The Wichard snap hooks will never break suddenly! They show signs of deformation long before reaching the breaking point.

"HR" Shackles

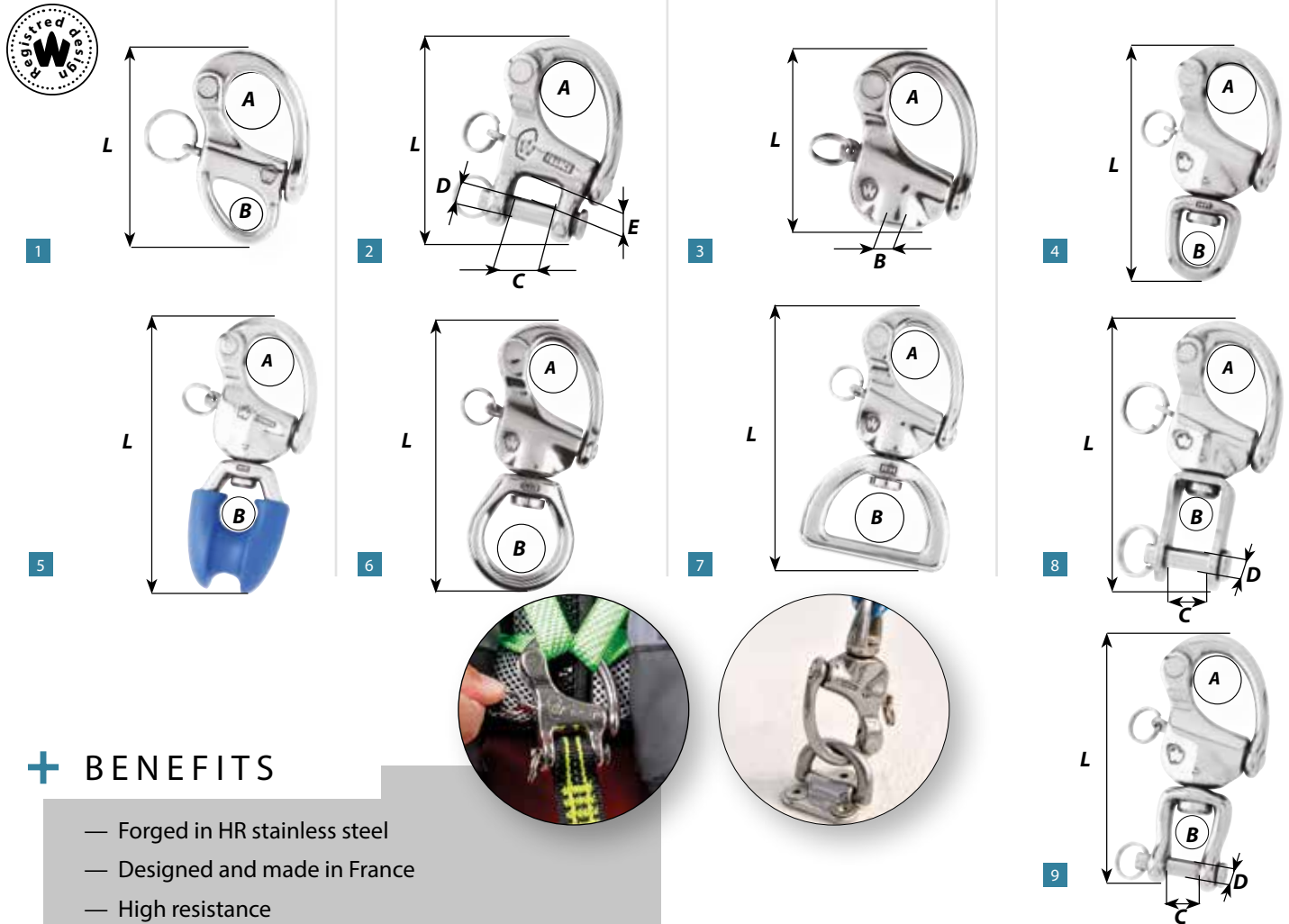

+ BENEFITS

- Forged in HR stainless steel
- Designed and made in France
- High resistance
- Captive plunger pin
- Large range
- Easy opening
- Multi-use: halyards, tethers etc...

N°	Part #	Length mm	A mm	B mm	C mm	Ø D mm	E mm	W.L. Kg	B.L. Kg	Weight Kg
FIXED EYE										
1	2470*	35	8	6				160	400	0.012
	2471	50	16	10				960	2000	0.042
	2472	70	21	13				1280	3000	0.090

N°	Part #	Length mm	A mm	Metric thread (Iso) B	W.L. Kg	B.L. Kg	Weight Kg
CLEVIS PIN							
2	2293	52	16	8	5,10	960	0.054
	2295	70	21	11,5	7,80	1280	0.130
	2297	86	26	14	9,30	2800	0,257

N°	Part #	Length mm	A mm	Metric thread (Iso) B	W.L. Kg	B.L. Kg	Weight Kg
WITHOUT SWIVEL WITH FEMALE THREAD							
3	72473	45	16	M7 x 75			0.042
	72475	60	21	M9 x 75			0.096
	72477	80	26	M12 x 100			0.222

N°	Part #	Length mm	A mm	B mm	C mm	Ø D mm	E mm	W.L. Kg	B.L. Kg	Weight Kg
SWIVEL EYE										
4	2473	70	16	11				960	2000	0.065
	2475	90	21	14				1280	3700	0.136
	52475*	90	Titanium					1200	2800	0.094
	2477	120	26	21				2800	7000	0.353

N°	Part #	Length mm	A mm	B mm	W.L. Kg	B.L. Kg	Weight Kg
WITH THIMBLE EYE							
5	2493	95	16	12	960	2000	0.076
	2495	110	21	14	1280	2400	0.150

N°	Part #	Length mm	A mm	B mm	W.L. Kg	B.L. Kg	Weight Kg
LARGE BAIL							
6	2373	80	16	19	960	2000	0.070
	2375	105	21	26	1280	3600	0.160
	2377	140	26	35	2800	7500	0.398

N°	Part #	Length mm	A mm	B mm	W.L. Kg	B.L. Kg	Weight Kg
WEBBING SWIVEL							
7	2374	80	16	30	960	2000	0.085
	2376	100	21	40	1280	3850	0.170

N°	Part #	Length mm	A mm	B mm	C mm	Ø D mm	E mm	W.L. Kg	B.L. Kg	Weight Kg
WITH CLEVIS PIN SWIVEL										
8	2474	70	16	15	12	6		800	1600	0.071
9	2476	90	21	17	11	7		1280	3800	0.154
9	2478	120	26	27	18	11		2400	7000	0.417

WL: working load - BL: breaking load

*Note parts #: 2470 and 52475 are not «HR»

Speedlink trigger snap shackles

Lightweight:

Speedlink was developed using finite element analysis software, and has an optimised design. Its shape, cut-outs and ribs make it extremely light, and give it one of the best strength/weight ratios on the market.

A modern design...

Speedlink's ultra-technical lines make it one of the most modern and efficient snap shackles available.

- The special load-bearing surface of the swivel eye avoids excessive rope wear.
- Its overall design prevents adjacent lines from jamming.

... for efficient operations

- Easy opening: opening under load, by using the release fid, is easy and effortless thanks to the generous passage diameter and its optimised slopes.
- Secure locking: the special shape of the latch reduces inertia and avoids unintentional opening, especially under impact, while the distribution of stresses limits the effort needed to open it under load.

Sturdy:

Speedlink is forged in HR stainless steel and can bear exceptional working and breaking loads for a minimum weight.

Universal eye:
Halyard - Spinnaker - Peeling

+ BENEFITS

- Universal eye version
- For halyards, spinnaker sheets...
- Can handle 2 sheets or 1 sheet and 1 snap hook/shackle
- Forged in HR s/s
- Designed and made in France

Webbing eye: Tack point

+ BENEFITS

- Webbing eye version
- For foresail tack points
- Optimized design for fitting to webbing
- Forged in HR s/s
- Designed and made in France

N°	Part #	Length mm	A mm	B mm	C mm	W.L. Kg	B.L. Kg	Weight Kg
UNIVERSAL EYE: FOR HALYARD, SPINNAKER AND PEELING								
1	2650	74	14	11,5		1100	2300	0,059
	2652	87	17	15,5		1440	3400	0,097
	2654	108	21	22		2320	5400	0,173
	2656	134	25	26		4300	8700	0,326

N°	Part #	Length mm	A mm	B mm	C mm	W.L. Kg	B.L. Kg	Weight Kg
EYE FOR WEBBING: FOR TACK POINT APPLICATIONS								
2	2750	72	14	11	23	1100	2000	0,058
	2752	83	17	13	26	1440	3400	0,095
	2754	102	21	17	35	2320	5400	0,174
	2756	128	25	21	59	4300	8700	0,337

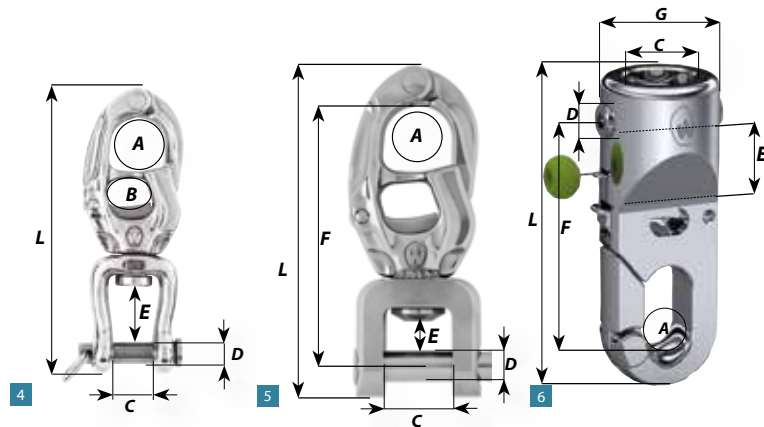

Trigger snap shackles

N°	Part #	Length mm	A mm	B mm	C mm	D mm	E mm	W.L. Kg	B.L. Kg	Weight Kg
SWIVEL SHACKLE (HR STAINLESS STEEL)										
4	2852	105	17	13	11	7	18	1440	3400	0.110
	2856	135	27	19	18	11	26	4100	8700	0.360

N°	Part #	Length mm	A mm	C mm	D mm	E mm	F mm	W.L. Kg	B.L. Kg	Weight Kg
VERSION WITH FORK (HR STAINLESS STEEL)										
5	2956	129	25	26	12	17.10	110	4300	8700	0.400

N°	Part #	Length mm	A mm	C mm	D mm	E mm	F mm	G mm	W.L. Kg	B.L. Kg	Weight Kg
TRIGGER SNAP SHACKLE 8T											
6	2957	126	17	28.3	14	12.5	94	47	8000	13000	0.400

WL: working load - BL: breaking load

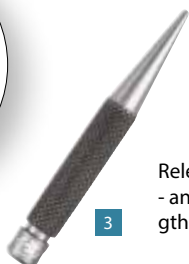
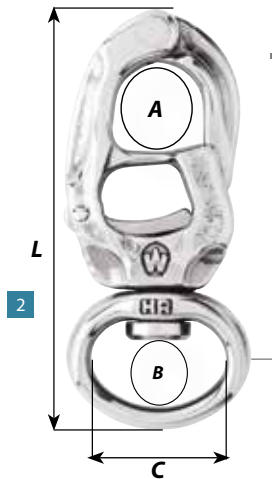

Release fid
- anodised aluminium - Length: 15 cm - Part # 10302

Opening luff Rope Prefeeder for racing foils and furling systems

Performance

Before re-hoisting, the Bowman doesn't need to remove the headsail from the luff groove, he just has to open the prefeeder and close it around the luff tape. No need to remove the headsail anymore!

Ease of use

To open it simply push the spring with your thumb, the jaws will open automatically. To close, squeeze the jaws together between your thumb and fingers, until the spring reengages.

Features:

- Single handed operation by pushing on the spring
- Easy to install with a lashing or fixed to the forestay
- Stainless steel product benefiting from the Wichard know-how to offer the highest reliability
- Weight: 0.050 kg
- Part # 7485

Easy to install

The prefeeder can be easily installed below any headsail foil or headsail reefing configuration. In the closed position, it ensures a smooth and easy sail hoist.



Quick release snap shackles

+ BENEFITS

- Forged in HR stainless steel
- Designed and made in France
- Available with swivel eye, large eye and tack snap configuration
- Ideal for sheets (genoa, spinnaker)
- Outstanding working loads
- Control line for easy release
- Aesthetic

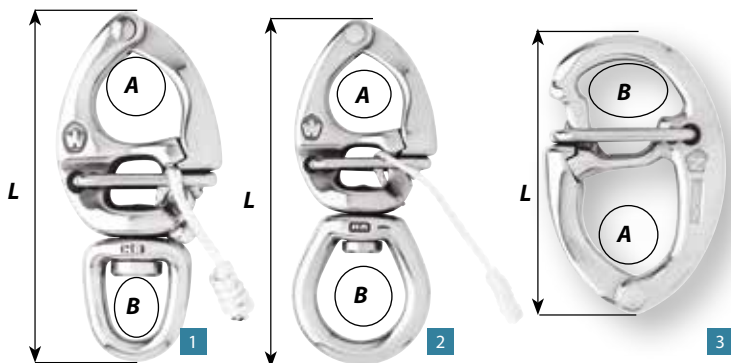

N°	Part #	Length mm	A mm	B mm	W.L. Kg	B.L. Kg	Weight Kg
WITH SWIVEL EYE							
1	2673	70	14	11	880	1500	0.059
	2674	80	16	12	1280	2300	0.088
	2675	90	20	13,5	1600	3200	0.136
	2676	110	25	16	2400	4200	0.233
	2677	130	30	20	3200	6300	0.371
	2678	150	34	24	5200	9000	0.548

N°	Part #	Length mm	A mm	B mm	W.L. Kg	B.L. Kg	Weight Kg
WITH LARGE BAIL							
2	2773	80	14	19	880	1300	0.054
	2774	90	16	23	1280	2000	0.100
	2775	110	20	26,5	1600	3000	0.160
	2776	120	25	31	2400	4000	0.271
	2777	145	30	35,5	2800	6300	0.396
	2778	160	34	41	5200	8000	0.618

N°	Part #	Length mm	A mm	B mm	W.L. Kg	B.L. Kg	Weight Kg
TACK SNAP SHACKLE							
3	2575	70	20	25	1280	2300	0.095

Double action Safety hooks



+ BENEFITS

- Registered design - Made in France
- Forged in 316L stainless steel
- Torsion spring
- Opens with one hand
- No risk of accidental opening
- Integrated into the Wichard tethers



N°	Part #	Colour	Length mm	A mm	B mm	W.L. Kg	B.L. Kg	Weight Kg
DOUBLE ACTION SAFETY HOOK «PATENTED»								
1	2454	Yellow	115	18	19 x 10	1200	2800	0.126
2	2455	Blue	115	18	19 x 10	1200	2800	0.126
3	2452	Fluorescent	115	18	19 x 10	1200	2800	0.126

Safety snap hooks

+ BENEFITS

- Registered design - Made in France
- Forged in 316L or HR stainless steel
- Outstanding working loads
- Aesthetic design
- Multi-use on board

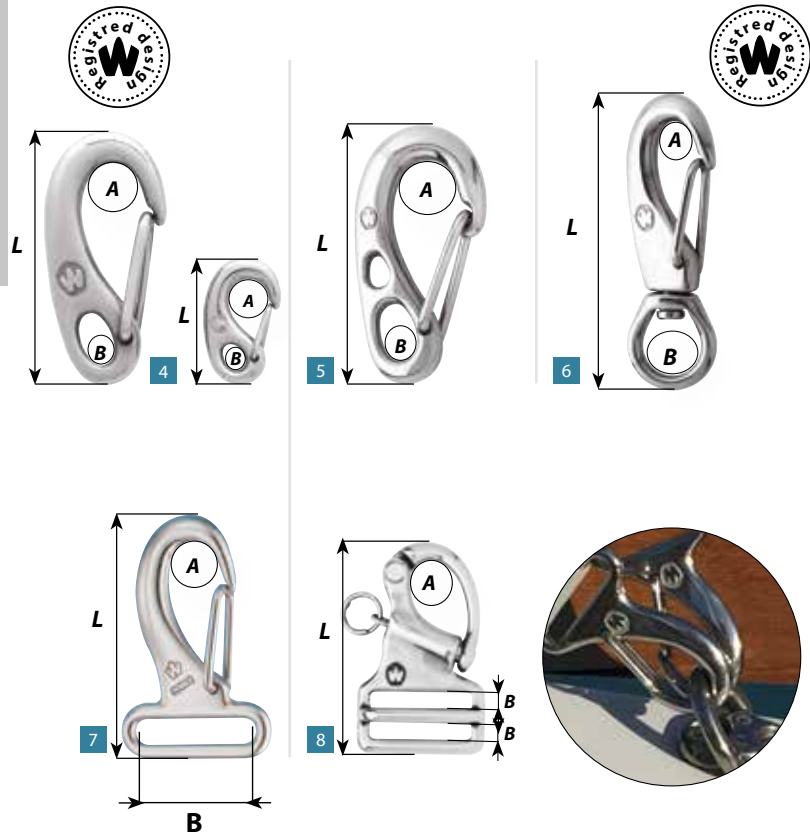

N°	Réf	Long mm	A mm	B mm	W.L. Kg	B.L. Kg	Weight Kg
SNAP HOOKS «PATENTED»							
4	2448	25	4	3	55	110	0.006
	2479	35	6	4	80	150	0.010
	2480	50	8	6	200	300	0.023
	2481	75	12	10	480	700	0.067
	2482	100	16	13	1120	1500	0.186

SAFETY SNAP HOOK «HR»							
<i>Models forged in 17.4 Ph (HR stainless steel)</i>							
5	2381	75	12	10	880	1600	0.064
	2382	100	17	14	1680	4000	0.167

SWIVEL SNAP HOOKS							
6	2384	70	8	13	200	300	0.036
	2385	100	12	19	480	750	0.102

WEBBING SNAP HOOK							
7	2284	60	8	30	200	300	0.035
8	2270	44	8	3	160	400	0.014

WL: working load - BL: breaking load

Carbine hook

N°	Part #	D mm	Length mm	A mm	B mm	W.L. Kg	B.L. Kg	W.L.L. Kg	Weight Kg
SYMMETRIC									
1	2313	6	60	10	7	360	600	120	0.030
	2315	8	80	13	11	880	1300	260	0.072
	2316	10	100	15	13	1200	2500	500	0.132
	2317	12	120	21	16	1360	3600	720	0.229
ASYMMETRIC									
2	2323	6	60	11	7	400	800	160	0.031
	2325	8	80	15	11	960	1500	300	0.073
	2326	10	100	18	13	1320	2500	500	0.136
	2327	12	120	24	16	1440	4500	900	0.234
	2328	12	170	30	20	1440	4500	900	0.336
WITHOUT EYE									
3	2333	6	60	10	8	360	600	120	0.028
	2335	8	80	13	13	880	1600	320	0.062
	2336	10	100	15	14	1200	2500	500	0.124
	2337	12	120	21	16	1360	3800	760	0.200

N°	Part #	D mm	Length mm	A mm	B mm	W.L. Kg	B.L. Kg	Weight Kg
DELTA HOOKS								
4	2345	8	80	13	40	720	1200	0.075
	2346	10	100	16	50	1120	2200	0.140



Working Load (WL): for nautical applications.



Working Load Limit (WLL): for industrial applications only.
The safety factor is 5 times the breaking load.
WLL = Breaking load / 5



+ BENEFITS

- Designed and made in France
- Available with eye to attach strap, or without eye
- Symmetric or asymmetric shape
- Perfect for fast operations
- Standard on Wichard tethers (part # 7001, 7002, 7011)
- Wichard carbine hooks bear the CE/WLL marking

"One hand" sail snaps

+ BENEFITS

- Ideal for setting a headsail
- One hand operation
- Available in 316L stainless steel or brass
- Efficient operation : does not jam

N°	Part #	Length mm	A mm	B mm	W.L. Kg	B.L. Kg	Weight Kg	
«ONE HAND» SAIL SNAPS								
4	2486	stainless steel	50	7,5	6,5	160	300	0.022
	2483	stainless steel	55	9	8	240	400	0.037
	2487	stainless steel	65	11	10	400	550	0.059
	2489	stainless steel	80	13	11,5	560	800	0.100
	2488	stainless steel	90	17	13	800	1050	0.143
	2490	stainless steel	110	24	15	960	1300	0.244
5	72486	brass	50	7,5	6,5	80	100	0.030
	72483	brass	55	9	8	120	180	0.036
	72487	brass	65	11	10	200	250	0.056

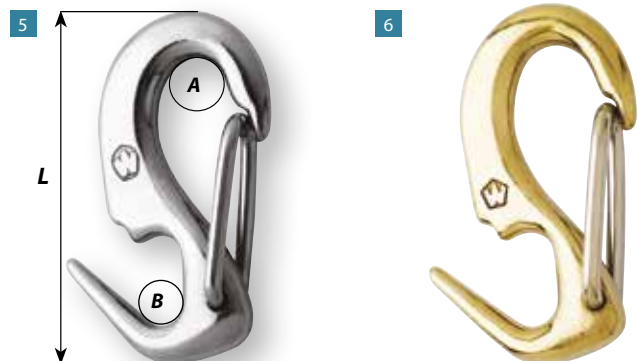

Mooring hooks

+ BENEFITS

- 2 models available: simple or automatic
- Can be used on most boat hooks
- Perfect for mooring buoys



N°	Part #	Ø mm	Length mm	A mm	B mm	Weight Kg
SIMPLE MOORING HOOKS (incl spare attachment fitting)						
1	92326	10	100	18	13	0.176
	92327	12	120	24	16	0.280
	92328	12	170	30	20	0.378

N°	Part #	Description	Weight Kg
SPARE ATTACHMENT FITTING FOR MOORING HOOKS			
2	72326	For part # 92326 - Weight: 0.025 Kg	
	72327	For parts # 92327 and 92328 - Weight: 0.035 Kg	

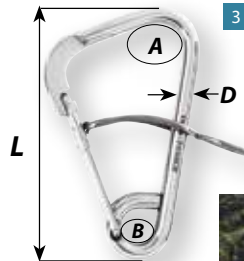

N°	Part #	D mm	Length mm	A mm	B mm	Weight Kg
AUTOMATIC MOORING HOOKS						
3	2329	Automatic	12	170	30	0,380



Chain grips

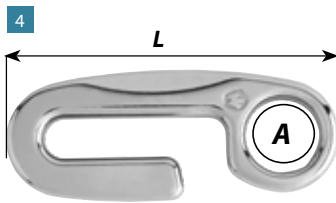

+ BENEFITS

- Perfect to ensure a safe anchoring by easing the tension on the anchor chain
- Protects the boat by reducing the chafe of the chain on rub rail and roller chock
- Positioned between two links of the chain (single handed operation)
- Optimized design to avoid accidental release of the chain
- One piece with non moving parts
- Forged in Duplex stainless steel grade (increased mechanical & corrosion resistance)
- Made in France

N°	Part #	Length mm	A mm	W.L. Kg	Weight Kg	
CHAIN GRIP						
4	2994	For 8 mm chain	85	17	480	0.088
	2995	For 10 mm chain	103	22	720	0.156
	2996	For 12 mm chain	125	24	960	0.287

Rings and adjusters

Wichard stainless steel rings and adjusters are hot drop forged from 316L stainless steel in a single piece, not just bent and welded. Forging is a far superior process, because it maintains the structural integrity of the metal and increases working load limits in real world applications. Each part is polished and passivated to create a beautiful, yet durable surface that is highly resistant to corrosion. The “W” pentagon (plus 316L) mark stamped into each part is your Wichard quality assurance.



Part #	N°	Description	A mm	B mm	C mm	D mm	E mm	F mm	G mm	B.L Kg	Weight Kg
RING											
6782	1	Ring	5	-	21.5	-	31.5	-	-	2000	0.014
6783		Ring	5	-	33	-	43	-	-	2000	0.018
6784		Ring	7.3	-	45	-	59.6	-	-	4000	0.057
6711	2	D Ring	6	-	40.4	21	33	52.4	-	3000	0.029
6712		D Ring	6	-	50.2	26.4	38.5	62.2	-	3000	0.035
6721	3	D Ring	5	-	30	25	35	40	-	2000	0.019
16504	4	«HR» D Ring	6	-	28	17	29	45.5	-	2700	0.026
16505		«HR» D Ring	7.3	-	36.5	22	37.5	59	-	4500	0.058
16506		«HR» D Ring	10	-	46.9	28.5	47.4	75.3	-	9000	0.120
ADJUSTERS											
6731	5	Triangle	4.4	18.2	30	20.6	28.6	38	-	1200	0.010
6732		Triangle	6	28.2	50	32.5	45	63	-	3000	0.037
6751	6	Triangle with bar	6.3	24.5	45	26	10	57.6	54.9	3000	0.058
6771	7	Double adjuster	4	-	41.5	5	7	58	38	1200	0.051
6772	8	Double adjuster	5-8	-	44.7	13.8	14.7	60	47.8	3000	0.078

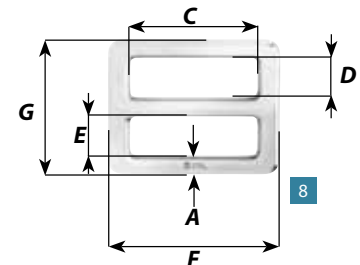
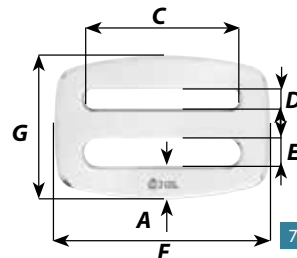
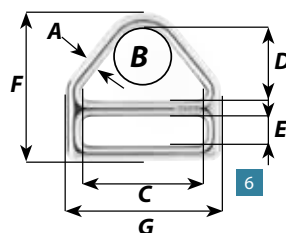
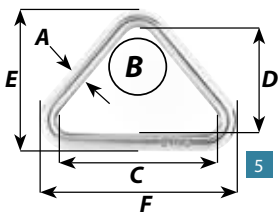
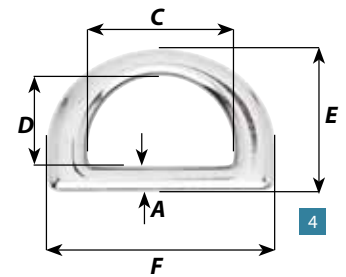
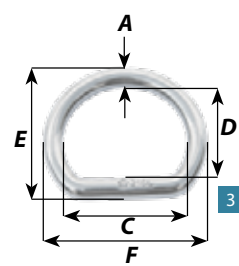
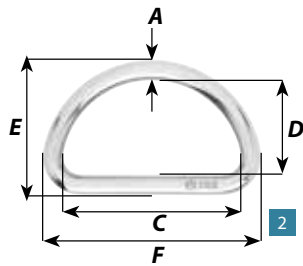
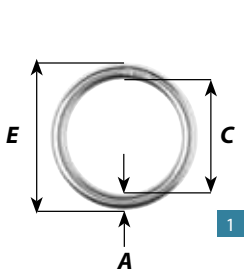



Swivels



The Wichard swivels are used to link two parts which may have different rotation directions. Wichard offers a complete range of swivels forged either with HR stainless steel or grade 316L stainless steel.

Wichard offers a complete range of swivels:

- With clevis pin or pin with allen head.
- With large bail.
- For webbing applications.
- For mooring applications.

Swivels

Swivels « HR »

+ BENEFITS

- Full range of products
- Forged in 17.4 Ph HR stainless steel
- Outstanding working and breaking loads
- Ball bearing models available
- Multi-use on board
- HR swivels are not recommended for use underwater

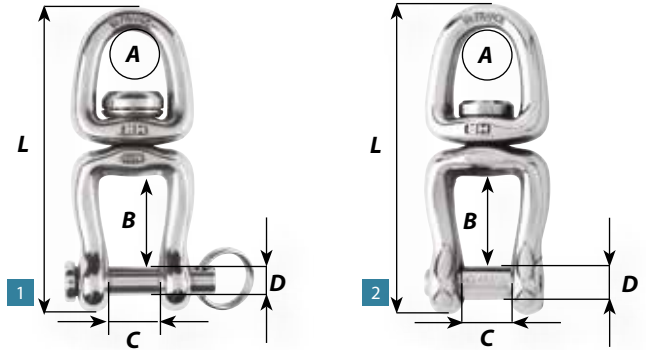

N°	Part #	Length mm	A mm	B mm	C mm	Ø D mm	W.L. Kg	B.L. Kg	Weight Kg
----	--------	-----------	------	------	------	--------	---------	---------	-----------

WITH CLEVIS PIN

1	2464	70	14	21	11	7	1600	2800	0.087
	82464	70	same with ball bearings				1600	2800	0.087
	2465	105	19	31	18	11	3200	6000	0.280
	82465	105	same with ball bearings				3200	6000	0.280

PIN WITH ALLEN HEAD

2	2364	70	14	21	11	8	1440	2800	0.084
	2365	105	19	31	18	10	3200	5500	0.265

LARGE BAIL

3	2467	80	26	14			1600	3000	0.096
	82467	80	same with ball bearings				1600	3000	0.096
	2468	115	35	19			3200	6500	0.263
	82468	115	same with ball bearings				3200	6500	0.268
	2466	125	41	21			5200	8500	0.368

WEBBING SWIVEL

4	2367	60	11	30			960	1500	0.056
	2368	80	14	40			1600	3200	0.107

Fork - FORK (SS CAMBERED PLATE)

5	2461*	45	9	10	10	5	480	1000	0.026
	2462*	60	15	13	12	6	720	1400	0.052

* Parts # 2461 and 2462 are not "HR".

TRADUCTION

6	2463	80	20	17	11	8	1440	2800	0.102
	2469	120	30	27	18	10	2000	5000	0.322

ALLEN HEAD PIN

7	2363	80	20	17	11	8	1440	2800	0.099
	2369	120	31	27	18	10	2000	5000	0.312

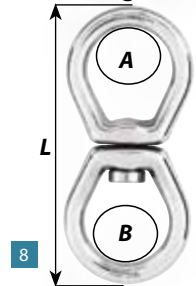
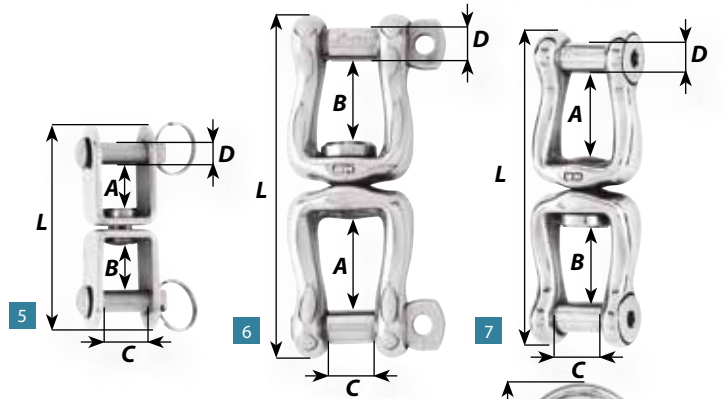
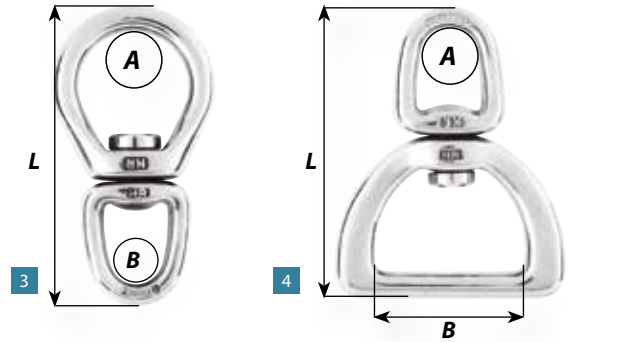

Mooring swivels

+ BENEFITS

- Forged in specific grade of stainless steel
- Designed and made in France
- Excellent corrosion resistance
- To be used with shackles # 1206, 1207, 1246, 1247 and 1248

N°	Part #	Length mm	A mm	B mm	W.L. Kg	B.L. Kg	Weight kg
MOORINGS SWIVEL							
8	2442	130	38	35	1760	4000	0.290
	2443	150	44	41	2960	5500	0.415

WL: working load - BL: breaking load



Shackles



The quality of our products, and in particular our shackles, has proven its worth in many applications and especially in extreme sports.

Why choose a Wichard shackle?

- Remarkably strong
- Optimal size and weight
- Proven resistance to corrosion
- Quality manufacturing
- A wide range of products

Accessories on page 32

A wide range of products

Wichard provides the most complete range of shackles on the market. You'll find the right Wichard shackle for your boat or other applications.

+ A WIDE CHOICE AVAILABLE:

- Rope diameter: 4 mm to 24 mm
- Breaking load: 700 kg to 35 tonnes

+ VARIOUS MATERIALS:

316L S/Steel, 17.4 PH (HR) S/Steel, Duplex S/Steel or titanium; it's your choice:

- 316L stainless steel: the right compromise between strength and resistance to corrosion.
- 17.4 PH (HR) stainless steel: for greater mechanical strength.
- Titanium (Ta6V): when weight saving is the priority

+ VARIOUS FUNCTIONS:

Self-locking pin, captive pin, quick-release pin, allen head pin... Wichard makes different versions for various applications.

+ CE MARKING:

Some of our products can be used as lifting accessories and as such bear the CE marking (awarded under the auto-certification scheme in accordance with the Machines Directive 2006/42).

Each product displays the following information

- Working Load Limit (WLL)
- CE marking, product origin, manufacturer's logo
- Materials



Captive pin shackle - no risk of losing the pin



Self-locking pin - avoids accidental release due to vibrations

+ VARIOUS SHAPES

Our shackles come in various shapes to ensure they do a proper job, in the right conditions, and last for a long, long time.



Working Load (WL): for nautical applications.



Working Load Limit (WLL): for industrial applications only. The safety factor is 5 times the breaking load. $WLL = \text{Breaking load} / 5$

Self-locking shackles



+ BENEFITS

- Large range of self-locking shackles
- Head of shackle pin locked into one of the notches
- Avoids accidental release due to vibrations
- Available in various versions to suit many applications
- Forged in 316L stainless steel
- Designed and made in France



N°	Part #	Dia D mm	A mm	B mm	C mm	D mm	E mm	F mm	G mm	H mm	M mm	W.L. Kg	B.L. Kg	W.L.L. Kg	Weight Kg
----	--------	----------	------	------	------	------	------	------	------	------	------	---------	---------	-----------	-----------

SELF-LOCKING D SHACKLES

1	1201	4	13	8	4	8	3	23	20	-	-	320	700	140	0.007
	1202	5	16	10	5	10	4	29	26	-	-	400	1000	200	0.013
	1203	6	20	12	6	12	5	34	31	-	-	600	1600	320	0.022
	1204	8	26	16	8	16	7	45	41	-	-	1000	2700	540	0.055
	1205	10	33	20	10	19	9	57	52	-	-	1520	4300	860	0.098
	1206	12	42	27	12	24	11	73	62	-	-	2080	6000	1200	0.193
	1207*	14	47	28	14	28	13	82	78	-	-	2400	8000	1600	0.312

SELF-LOCKING LONG SHACKLES

2	1211	4	22	8	4	8	4	32	21	-	-	320	700	140	0.08
	1212	5	29	10	5	10	4	41	26	-	-	400	1000	200	0.017
	1213	6	33	12	6	12	5	47	31	-	-	600	1600	320	0.027
	1214	8	45	16	8	16	7	64	41	-	-	1000	2700	540	0.066
	1215	10	55	20	10	19	9	79	52	-	-	1520	4300	860	0.128

SELF-LOCKING TWISTED SHACKLE

3	1222	5	26	10	5	10	4	38	26	-	-	480	1100	-	0.016
	1223	6	30	12	6	12	5	45	31	-	-	600	1500	-	0.027
	1224	8	40	16	8	16	7	60	41	-	-	1000	3000	-	0.067
	1225	10	50	20	10	19	9	74	52	-	-	1440	4500	-	0.127

SELF-LOCKING BOW SHACKLES

4	1241	4	18	8	4	8	3	28	20	13	21	320	700	140	0.009
	1242	5	23	10	5	10	4	35	25	16	25	400	1000	200	0.017
	1243	6	28	12	6	12	5	43	33	19.5	32	600	1500	300	0.030
	1244	8	37	16	8	16	7	56	41	25.5	39	1000	2700	540	0.068
	1245	10	47	20	10	20	9	71	52	32	52	1520	4300	860	0.137
	1246	12	55	24	12	24	10	87	61	38.5	63	2080	6000	1200	0.233
	1247*	16	70	32	14	32	15	112	88	51	85	3200	10000	2000	0.540
	1248*	20	80	40		40	18	135	108	60	100	4500	15000	3000	1.056

SELF-LOCKING LARGE OPENING SHACKLE

5	1262	5	36	20	5	11	5	48	35	-	-	330	1100	220	0.016
	1263	6	42	25.5	6	14	6	58	44	-	-	450	1500	300	0.027
	1264	8	57	32	8	17	8	77	57	-	-	810	2700	540	0.067
	1265	10	72	40	10	21	10	99	71	-	-	1280	4000	800	0.127

ALLEN HEAD PIN SHACKLES «D»

The head of the pin does not stick out from the shackle's body, thus eliminating any risk of snagging.

6	1303	6	19	12	6	12	5	34	25	-	-	600	1600	320	0.022
	1304	8	26	16	8	16	7	46	33	-	-	960	2700	540	0.053
	1305	10	33	20	10	19	9	57	41	-	-	1440	4300	860	0.099
	1306	12	39	24	12	24	10	73	49	-	-	2080	6000	1200	0.187
	1363	6	42	25.5	6	14	6	58	38	-	-	450	1500	300	0.044

(specially designed for batten cars)

ALLEN HEAD PIN LONG SHACKLES

7	1313	6	33	12	-	-	-	-	-	-	-	600	1600	-	0.027
	1314	8	45	16	-	-	-	-	-	-	-	1000	2700	-	0.066

ALLEN HEAD PIN SHACKLES «BOW»

The head of the pin does not stick out from the shackle's body, thus eliminating any risk of snagging.

8	1343	6	27	12	6	12	5	42	24	-	32	600	1500	300	0.029
	1344	8	37	16	8	16	7	56	32	-	40	960	2700	540	0.067
	1345	10	47	20	10	20	9	72	40	-	52	1440	4300	860	0.133
	1346	12	55	24	12	24	10	87	50	-	63	2080	6000	1200	0.222

TACK SHACKLES

These shackles are specially designed for adjustment to the width of goosenecks.

9	1233	6	45	16	6	13	4	60	33	-	-	520	1500	-	0.048
	1234	8	59	21	8	17	6	79	45	-	-	800	2300	-	0.110

WL: working load - BL: breaking load

* Parts # 1247, 1248 and 1207 are not self-locking shackles.

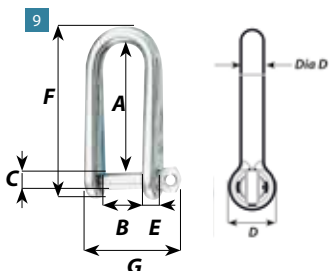
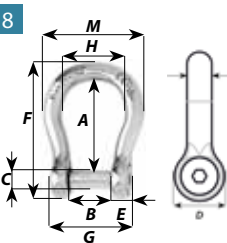
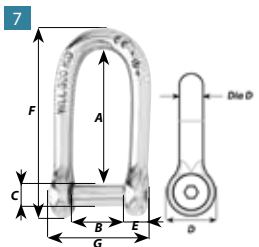
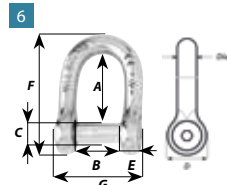
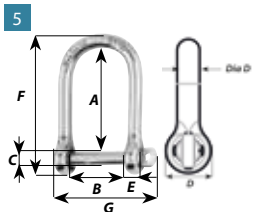
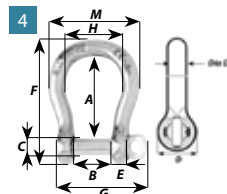
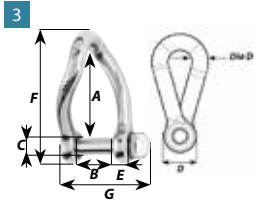
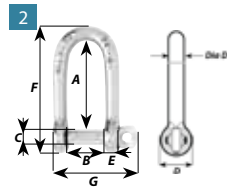
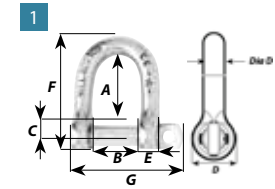

Captive pin shackles

N°	Part #	Dia d mm	A mm	B mm	C mm	D mm	E mm	F mm	G mm	H mm	M mm	W.L. Kg	B.L. Kg	W.L.L. Kg	Weight Kg
CAPTIVE PIN «D» SHACKLES															
1	1401	4	13	8	5	9	4	24	22	-	-	320	1000	200	0.009
	1402	5	16	10	6	11	5	11	30	-	-	480	1500	300	0.016
	1403	6	20	12	7	14	6	36	32	-	-	680	2200	440	0.028
	1404	8	26	16	9	18	8	47	42	-	-	1080	3600	720	0.061
	1405	10	33	20	11	21	9	58	53	-	-	1560	5200	1040	0.114
	1406	12	39	24	13	24	11	69	62	-	-	2100	7000	1400	0.188

N°	Part #	Dia d mm	A mm	B mm	C mm	D mm	E mm	F mm	G mm	H mm	M mm	W.L. Kg	B.L. Kg	W.L.L. Kg	Weight Kg
CAPTIVE LONG «D» SHACKLES															
2	1411	4	31	8	5	9	4	41	22			320	1000	200	0.012
	1412	5	39	10	6	11	5	52	27			480	1500	300	0.024
	1413	6	46	12	7	14	6	63	32			680	2200	440	0.040
	1414	8	62	16	9	17	8	82	43			1080	3600	720	0.092
	1415	10	78	20	11	21	10	103	54			1560	5200	1040	0.176

N°	Part #	Dia d mm	A mm	B mm	C mm	D mm	E mm	F mm	G mm	H mm	M mm	W.L. Kg	B.L. Kg	W.L.L. Kg	Weight Kg
CAPTIVE TWISTED SHACKLES															
3	1422	5	37	10	6	11	5	50	27			480	1100	-	0.023
	1423	6	44	12	7	14	6	60	31			600	1500	-	0.039
	1424	8	59	16	9	18	8	80	42			1000	3000	-	0.090
	1425	10	74	20	11	21	9	99	53			1520	4500	-	0.170

N°	Part #	Dia d mm	A mm	B mm	C mm	D mm	E mm	F mm	G mm	H mm	M mm	W.L. Kg	B.L. Kg	W.L.L. Kg	Weight Kg
CAPTIVE PIN BOW SHACKLES															
4	1441	4	18	8	5	9	4	28	20	13	21	320	1000	200	0.010
	1442	5	23	10	6	11	5	35	25	16	26	480	1500	300	0.019
	1443	6	27	12	7	14	6	43	31	19	31	660	2200	440	0.033
	1444	8	37	16	9	18	8	56	41	25	42	1110	3700	740	0.075
	1445	10	46	20	11	21	9	72	52	31	52	1560	5200	1040	0.139

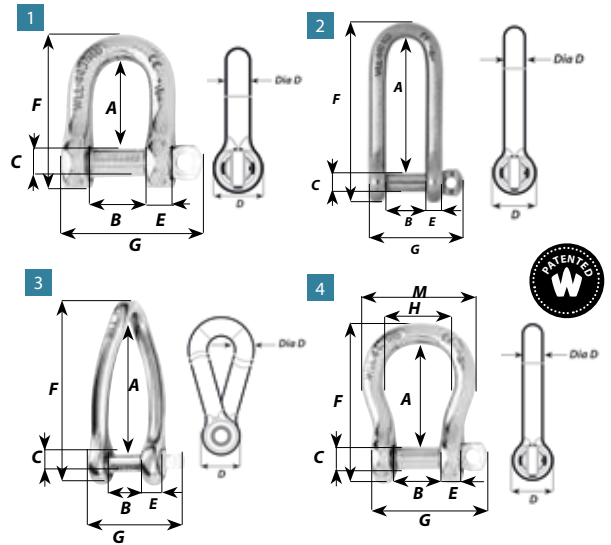

+ BENEFITS

- Self-locking pin cannot be dropped when opened
- No risk of losing the pin
- Wide range to meet all needs
- Forged in 316L stainless steel
- Designed and made in France

Key pin shackles

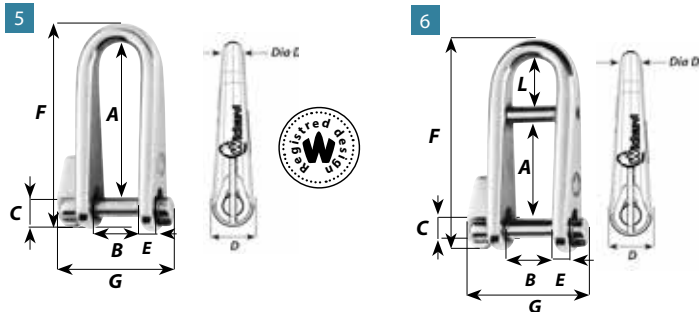

+ BENEFITS

- Patented design
- Opening by half turn
- Easy to install with one hand
- Forged in 316L stainless steel
- Designed and made in France

N°	Part #	Dia d mm	A mm	B mm	C mm	D mm	E mm	F mm	G mm	L mm	W.L. Kg	B.L. Kg	Weight Kg
KEY PIN SHACKLES													
5	1432	55	337	133	5	11	4	49	31	-	400	1000	0.031
	1433	66	485	166	6	13	4	60	37	-	520	1500	0.048
	1434	88	599	221	8	17	6	79	49	-	800	2300	0.121

N°	Part #	Dia d mm	A mm	B mm	C mm	D mm	E mm	F mm	G mm	L mm	W.L. Kg	B.L. Kg	Weight Kg
KEY PIN SHACKLES WITH BAR													
6	81432	55	337	133	5	11	4	49	31	12	400	1200	0.031
	81433	66	485	166	6	13	4	60	37	15	520	1700	0.052
	81434	88	599	221	8	17	6	79	49	20	800	2500	0.123

WL: working load - BL: breaking load

Thimble shackles

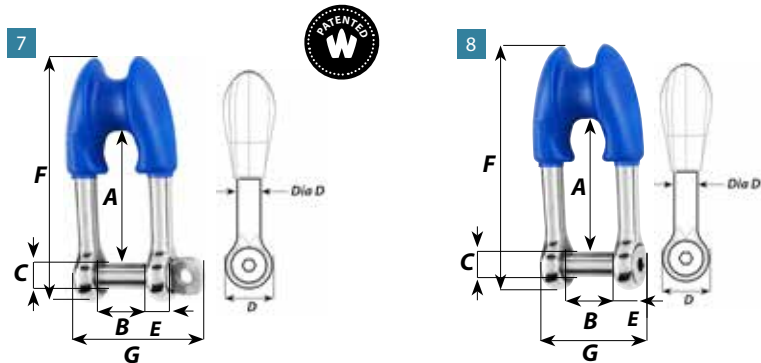

+ BENEFITS

- Forged in 316L stainless steel
- Allows splicing on head of shackle
- No additional stainless steel cringles
- Designed and made in France

N°	Part #	Dia d mm	A mm	B mm	C mm	D mm	E mm	F mm	G mm	Ø rope max. mm	W.L. Kg	B.L. Kg	Weight Kg
CAPTIVE PIN													
7	1494	8	41	16	8	16	7	76	42	12	1000	3000	0.078
	1495	10	51	20	10	20	9	95	54	16	1520	5000	0.146
ALLEN HEAD PIN													
8	1394	8	41	16	8	16	7	76	33	12	1000	3000	0.076
	1395	10	51	20	10	20	8	96	41	16	1520	5000	0.142

Titanium shackles

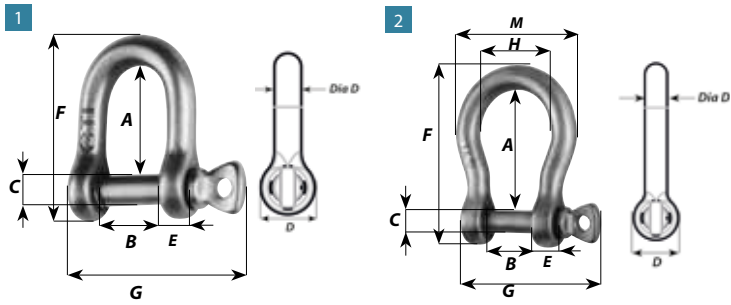

+ BENEFITS

- Forged in Titanium TA6V
- Important weight saving: 40%
- Available in D and bow models
- Designed and made in France

1 titanium shackle is up to 45% lighter than a standard 316L shackle.

N°	Part #	Dia d mm	A mm	B mm	c mm	D mm	E mm	F mm	G mm	H mm	M mm	WL Kg	BL Kg	Weight Kg
TITANIUM SHACKLES														
1	51203	6	20	12	6	12	5	35	35	-	-	880	1700	0.014
	51204	8	26	16	8	16	7	47	46	-	-	1440	3000	0.034
TITANIUM BOW SHACKLES														
2	51245	10	47	20	10	20	9	72	58	32	52	2160	6000	0.082
	51246	12	55	24	12	24	10	86	68	38	63	2800	8000	0.136

HR shackles

+ BENEFITS

- Forged in HR (High resistance) stainless steel
- Outstanding working loads
- Available in D, long, bow and key pin models
- Designed and made in France

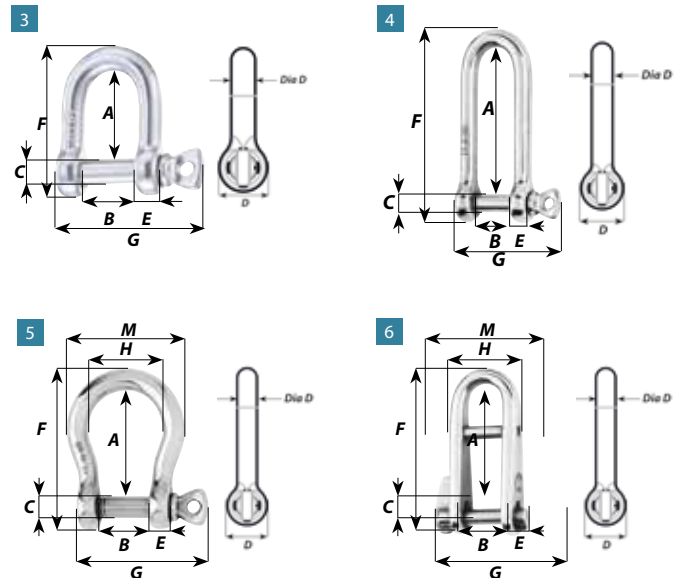

N°	Part #	Dia d mm	A mm	B mm	C mm	D mm	E mm	F mm	G mm	H mm	M mm	WL Kg	BL Kg	W.L.L Kg	Weight Kg
HR «D» SHACKLES															
3	11203	6	20	12	6	16	7	46	46	-	-	1040	2300	460	0.024
	11204	8	26	16	8	16	7	46	46	-	-	1760	4100	820	0.052
	11205	10	33	20	10	20	9	60	58			2640	6000	1200	0.102
	11206	12	39	24	12	24	13	72	68			3600	10000	2000	0.192
	11207	14	49	28	14	28	14	84	78			5120	12000	2400	0.304
	11208	16	56	32	16	32	16	96	87			6800	19000	3800	0.464
	11209	20	70	40	20	40	20	120	108			8800	28000	5600	0.860
HR LONG SHACKLES															
4	11215	10	78	20	10	20	9	80	58			2640	6000	1200	0.164
HR BOW SHACKLES															
5	11244	8	37	16	8	16	7	57	46	26	42	1760	4100	820	0.068
	11245	10	47	20	10	20	9	72	58	32	52	2640	6000	1200	0.136
	11246	12	55	24	12	24	10	86	68	38	63	3600	10000	2000	0.224
	11240	14	63	28	14	28	13	98	78	44	72	5120	12000	2400	0.364
	11247	16	70	32	16	32	15	113	87	50	83	6800	19000	3800	0.526
	11248	20	80	40	20	40	18	134	108	60	100	8800	28000	5600	1.011
	11249	24	108	48	24	47	20	168	131	70	118	12800	35000	7000	1.706

N°	Part #	Dia d mm	A mm	B mm	C mm	D mm	E mm	F mm	G mm	L mm	WL Kg	BL Kg	Weight Kg
HR KEY PIN SHACKLES WITH BAR													
6	91432	5	37	13	5	11	4	49	31	12	480	1500	0.031
	91433	6	45	16	6	13	4	60	37	15	600	2200	0.053
	91434	8	59	21	8	17	6	79	48	20	960	3500	0.123



Working Load (WL): for nautical applications.



Working Load Limit (WLL): for industrial applications only. The safety factor is 5 times the breaking load. WLL = Breaking load / 5

1 shackle forged in HR 17.4 Ph stainless steel can be up to 60% more resistant than a shackle in 316L stainless steel.

Softlink: soft shackle

The soft shackle for all!

+ BENEFITS

- No knowledge of ropework required
- Replaces shackles and snap hooks
- Easy to fit and easy to open
- Remarkably light and strong
- Re-usable
- 3 sizes available
- Materials: stainless steel and Dyneema® SK 78



Visit our **Wichard Sailing** YouTube channel and download the **Softlink** video

For the same strength, SoftLink is 4 or 5 times lighter than a 316L stainless steel shackle.

N°	Part #	W.L Kg	B.L Kg	Ø loop mm	Loop Length mm	Weight Kg
SOFTLINK 3.0 - SOFT SHACKLE						
1	21223	1500	2000	3	70	0.012
SOFTLINK 4.0 - SOFT SHACKLE						
2	21224	2300	3000	4	80	0.023
SOFTLINK 5.0 - SOFT SHACKLE						
3	21225	3800	5000	5	90	0.047



Accessories

N°	Part #	Description	Weight kg
KEY RINGS			
1	9304	Key ring with pin shackle # 1441	0.017
2	9305	Key ring with snap hook # 2480	0.029
3	9306	Key ring with snap shackle # 2470	0.029
4	9307	Key ring with block # 60019	0.019
2	9308	Key ring with snap hook # 2479	0.029

N°	Part #	Description	Weight kg
SHACKLER AND SPIKE TOOL			
5	10303	Forged shackler with bottle opener	0.033
6	10304	Unique shackler / spike tool	0.109



WL: working load - BL: breaking load

Maintenance

WICHINOX

New gel formula
Cleans and passivates stainless steel hardware

- Suitable for industrial applications
- Help reconstitute a passive protective film for stainless steel products
- Increases product longevity
- Easy to apply using a brush
- Use in the event of marked or deep-set corrosion (occasional use)
- Part #: 9605
- Volume: 250 ml





Blocks



Our blocks, wholly designed and manufactured in our factories, feature high-performance materials and are subjected to rigorous manufacturing and quality assurance processes. For whatever type of block, ball bearing, plain bearing, the shape of the sheave suits all modern ropes. They are also very easy to install due to the various types of fastening options.

Wichard offers a complete range of blocks:

- Rings
- Ball bearing and plain bearing blocks
- Snatch blocks
- Stainless steel blocks
- Deck accessories
- Roller blocks



Selection guide – blocks

	Plain bearing blocks	Ball bearing blocks	Roller blocks	FRX: Rings	MXEvo: Block	MXLEvo: Soft block

LOAD TYPES

Dynamic operation and light load						
Static operation and heavy load						
Dynamic operation and heavy load						

EXAMPLES OF USE

Mainsail sheet		✓	✓			
Mainsail travelers			✓	✓		
Spinnaker sheets			✓	✓		
Mastfoot block	✓			✓	✓	✓
Masthead block	✓					
Boom vang	✓				✓	✓
Downhaul	✓				✓	
Backstay	✓		✓	✓		
Mainsail foot	✓				✓	✓
Reefing point	✓				✓	
Cunningham	✓				✓	
Barberhauler		✓		✓		✓
Inhauler				✓		✓
Spinnaker tack point		✓	✓	✓		✓

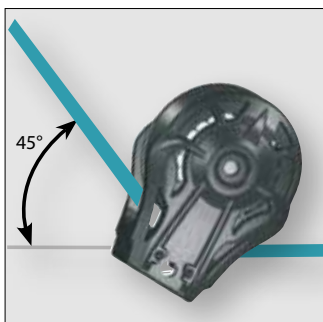

For a 45° angle: The load factor will be 75%. A load of 100 Kg on the line will represent a load of 75 Kg on the block.

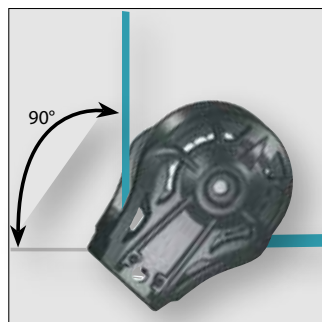

For a 90° angle: The load factor will be 140%. A load of 100 Kg on the line will represent a load of 140 Kg on the block.

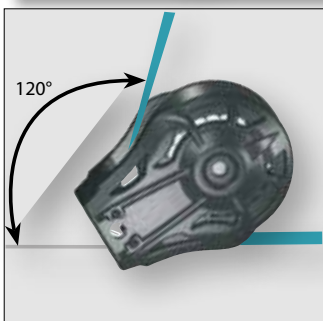

For a 120° angle: The load factor will be 180%. A load of 100 Kg on the line will represent a load of 180 Kg on the block.

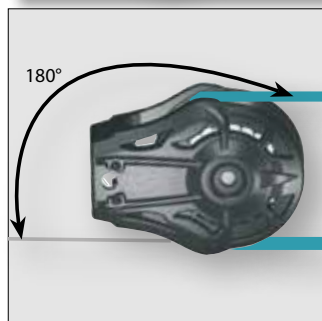

For a 180° angle: The load factor will be 200%. A load of 100 Kg on the line will represent a load of 200 Kg on the block.

Deflection angle	Load factor
180°	200%
160°	197%
140°	187%
120°	180%
100°	153%
90°	140%
80°	129%
60°	100%
45°	75%
20°	35%
0°	0%

Friction blocks

FRX : RINGS



+ BENEFITS

- 5 sizes available
- Very strong
- Very light
- Various applications: mast-foot block, inhauler, barber-hauler and more.
- Suitable for all types of rope (Dyneema®, etc.)
- Materials: hard anodized aluminium for greater lifespan

N°	Part Block	ØA mm	ØB mm	C mm	Ø D mm	WL Kg	Weight Kg	Material
FRX6								
1	20705	5.5	7	9	18	400	0.002	Aluminium
FRX10								
2	21008	8	10	12	25	800	0.005	Aluminium
FRX15								
3	21510	10	15	15	35	1600	0.012	Aluminium
FRX20								
4	22014	14	20	21	47	3200	0.031	Aluminium
FRX25								
5	22517	17	25	25	60	5000	0.057	Aluminium

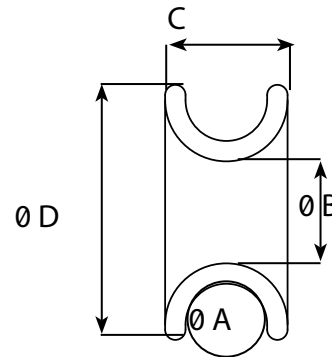

Applications
Mast-foot block, barber-hauler, inhauler, loop, thimble, lazyjack, running backstay, tackle, and more.



Friction blocks

MXLEvo : The universal soft block solution

The MXLEvo is a soft block solution designed for all yachtsmen, whether amateur or pro. Designed for heavy load applications (mast foot, halyard tackle, barber hauler, snatch blocks, etc.), this system is available in three sizes.

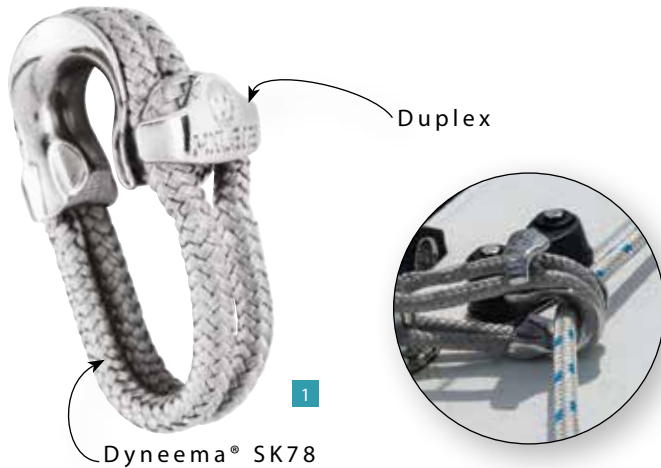

Fig	Part #	Height mm	Width mm	Thick mm	Loop length mm	nominal Ø loop mm	W.L. Kg	B.L. Kg	Weight Kg
MXLEVO 10 - FOR MAX ROPE SIZE 10 MM									
1	21104	30	40	26	170	4	800	2000	0.040
MXLEVO 12 - FOR MAX ROPE SIZE 12 MM									
1	21105	40	54	35	220	5	1600	3800	0.090
MXLEVO 16 - FOR MAX ROPE SIZE 16 MM									
1	21106	47	60	41	270	6	2500	5000	0.140

+ BENEFITS

- Economical and easy to use
- Designed for heavy load applications
- Lightweight, robust and highly compact
- A reliable solution and maintenance free
- Adaptable to your deck plan and anchor orientation: 2 fastening methods
- High quality materials: Duplex grade stainless steel -Dyneema® SK78
- Available in 3 sizes



MXLEvo provides exceptional resistance for its weight. In comparison with a standard competitor's block,

The MXLEvo 10 is:

- > twice as robust
- > half the weight
- > a third of the size

> For a breaking load of 5 tonnes, the MXLEvo 16 is 35% lighter.

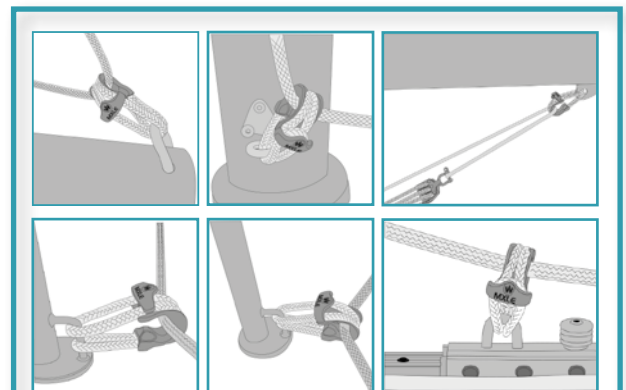

Heavy load applications:

- Mast foot block,
- Halyard tackle,
- Barber hauler,
- Block and tackle,
- Sheet return,
- Large sail foot, etc..

Friction blocks

MXEvo : Blocks

+ BENEFITS

- 2 VERSIONS AVAILABLE:
 - Captive pin version: 3 models
 - Allen head pin version: 3 models
- Perfect for taking on the heavy loads of flying sail furler terminals and 2:1 purchase mainsail halyards, mastfoot deflection
- Becket feature for purchase
- Outstanding working and breaking loads
- Optimised dimensions and weight
- Easy to install and use
- Reliable and maintenance free
- Helps to prevent excessive rope wear



MXEvo: Captive pin version

N°	Part # Captive pin version	Length mm	Width mm	Ø mm	A mm	B mm	Ø C mm	W.L. Kg	B.L. Kg	Weight Kg
MXEVO DIA 6 MM: CAPTIVE PIN - FOR MAX ROPE SIZE 8 MM										
1	11603	53	26	6	18	13	7	1040	2300	0,053
MXEVO DIA 8 MM: CAPTIVE PIN - FOR MAX ROPE SIZE 10 MM										
2	11604	62	36	8	18	18	9	1760	4100	0,109
MXEVO DIA 10 MM: CAPTIVE PIN - FOR MAX ROPE SIZE 14 MM										
3	11605	77	44	10	22	22	11	2640	6000	0,222

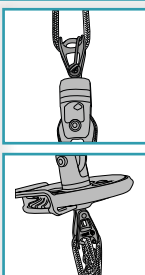

**MXEvo:
captive pin version**

This version is used for static lines:

- Flying sail furler terminal
- 2:1 mainsail halyard

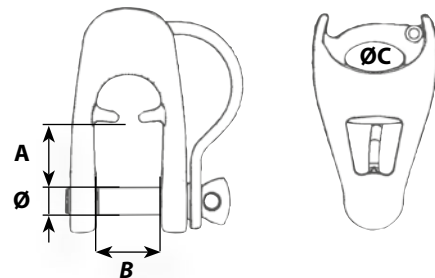

MXEvo: Allen head pin version

N°	Part # Allen head pin version	Length mm	Width mm	Ø mm	A mm	B mm	Ø C mm	W.L. Kg	B.L. Kg	Weight Kg
MXEVO DIA 6 MM: ALLEN HEAD PIN - FOR MAX ROPE SIZE 8 MM										
1	11613	53	26	6	18	13	7	720	1700	0,048
MXEVO DIA 8 MM: ALLEN HEAD PIN - FOR MAX ROPE SIZE 10 MM										
2	11614	62	36	8	18	18	9	1300	3500	0,100
MXEVO DIA 10 MM: ALLEN HEAD PIN - FOR MAX ROPE SIZE 14 MM										
3	11615	77	44	10	22	22	11	1760	5000	0,204

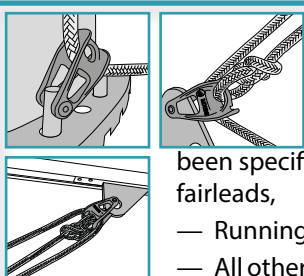

**MXEvo:
allen head pin version**

This version of the MXEvo has been specifically designed for Mast-foot fairleads,

- Running backstays
- All other applications that are not handled frequently.

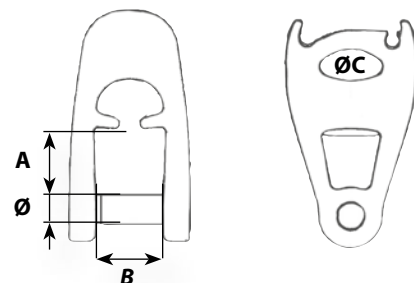

Stainless steel blocks

+ BENEFITS

- Large range covering all applications
- Lightness, reliability and good performance
- Wide choice of fastenings
- Perfect for dinghies and cruising yachts

N°	Part #	Description	Height mm	Width mm	Thick. mm	W.L. Kg	B.L. Kg	Weight Kg
SHEAVE DIA 18 MM - ROPE SIZE 6 TO 8 MM								
1	30018	Single block	45	21	11	200	500	0.016
2	30118	Single with becket	57	31	11	200	500	0.022
SHEAVE DIA 19 MM - ROPE SIZE 6 MM								
3	30019	Single with eye	38	19	8	200	500	0.012
SHEAVE DIA 24 MM - ROPE SIZE 4 TO 6 MM								
4	30024	Single with shackle	56	25	15	200	500	0.021
5	31124	Single block	42	25	15	200	500	0.014
6	30124	Single with becket and shackle	70	25	15	200	500	0.026
7	31224	Single with becket	56	25	15	200	500	0.014
8	30224	Single with V cleat, becket and shackle	70	33	15	200	500	0.034
9	30324	Single with V cleat and becket	56	33	15	200	500	0.028
10	30424	Double with shackle	56	25	19	200	500	0.030
11	30524	Double with becket and shackle	70	25	19	200	500	0.037
12	30624	Double with V cleat, becket and shackle	70	33	19	200	500	0.047
13	30724	Triple with shackle	56	25	27	200	500	0.040
14	30824	Triple with becket and shackle	70	25	27	200	500	0.060
15	30924	Triple with V cleat, becket and shackle	70	33	27	200	500	0.060
SHEAVE DIA 25 MM - ROPE SIZE 8 TO 10MM								
16	30025	For 25 mm stanchion	65	53	21	280	400	0.049
17	30125	For 25 mm stanchion, pivoting	95	53	21	280	400	0.070
18	30425	Swivel with clevis	59	25	21	200	300	0.036
SWIVEL SHACKLE BLOCKS								
19	30225	Flat 25 mm dia sheave	50	50	32	240	600	0.036
	30325	Curved 25 mm dia sheave	50	50	40	240	600	0.036
20	30136	Removable 36 mm dia sheave	36	65	58	800	2000	0.168
WIRE BLOCK WITH ALUMINIUM SHEAVE								
21	31024	24 mm dia sheave, for 3 mm wire	42	25	11	140	350	0.019
	30036	36 mm dia sheave, for 4 mm wire	66	39	11	200	500	0.050
	30050	50 mm dia sheave, for 5 mm wire	75	50	12	320	800	0.084
	30070	70 mm dia sheave, for 7 mm wire	105	70	17	1200	2500	0.222
22	30071	70 mm dia sheave, for 7 mm wire	150	70	17	1200	1790	0.298
SHEAVE DIA 45 MM - ROPE SIZE 10 MM								
Mast step blocks sheave dia 45 mm								
23	30045	Single with clevis pin	75	50	24	560	1000	0.076
24	30145	Swivel with clevis	105	50	24	560	1000	0.104
Land-yacht blocks (curved) sheave dia 50 mm								
25	31045	Single	85	50	24	320	800	0.104
26	31145	Single with becket	108	50	24	320	800	0.106

WL: working load - BL: breaking load



Blocks

plain bearing and ball bearing

SHEAVE DIA 12, 18, 25

SHEAVE DIA 12 (stainless steel sheave)

mini block - rope size 4 mm

N°	Part plain bear.	Description	Height mm	Width mm	Thick. mm	W.L. Kg	B.L. Kg	Weight Kg
1	60600	Fixed eye	33	16	11	120	300	0.011

SHEAVE DIA 18

rope size 4 to 6 mm

N°	Part plain bear.	Part ball bear.	Description	Height mm	Width mm	Thick. mm	W.L. Kg	B.L. Kg	Weight Kg
----	------------------	-----------------	-------------	-----------	----------	-----------	---------	---------	-----------

SINGLE BLOCKS

3	60113	70113	Fixed eye	35	18	14	240	500	0.011
4	60114	70114	Fixed eye with becket	45	18	14	240	500	0.015
6	60120	70120	Cheek block	36	18	14	240	500	0.010

DOUBLE BLOCKS

8	60213	70213	Fixed eye	45	18	28	320	700	0.041
9	60214	70214	Fixed eye with becket	55	18	28	320	700	0.044

TRIPLE BLOCKS

10	60313	70313	Fixed eye	45	18	42	480	900	0.055
11	60314	70314	Fixed eye with becket	55	18	42	480	900	0.057

SHEAVE DIA 25

rope size 6 to 8 mm

N°	Part plain bear.	Part ball bear.	Description	Height mm	Width mm	Thick. mm	W.L. Kg	B.L. Kg	Weight Kg
----	------------------	-----------------	-------------	-----------	----------	-----------	---------	---------	-----------

SINGLE BLOCKS

2	61105	71105	Swivel head	64	25	18	200	500	0.027
3	61113	71113	Fixed eye	49	25	18	320	600	0.019
4	61114	71114	Fixed eye with becket	62	25	18	320	600	0.024
5	61353	71353	Opposite in line	75	25	18	320	600	0.037
6	61120	71120	Cheek block	52	25	18	320	600	0.021
7	61121	71121	Upright lead block	39	32	42	320	600	0.032

DOUBLE BLOCKS

8	61213	71213	Fixed eye	64	25	34	400	800	0.059
9	61214	71214	Fixed eye with becket	78	25	34	400	800	0.062

TRIPLE BLOCKS

10	61313	71313	Fixed eye	60	25	51	480	1000	0.081
11	61314	71314	Fixed eye with becket	74	25	51	480	1000	0.087

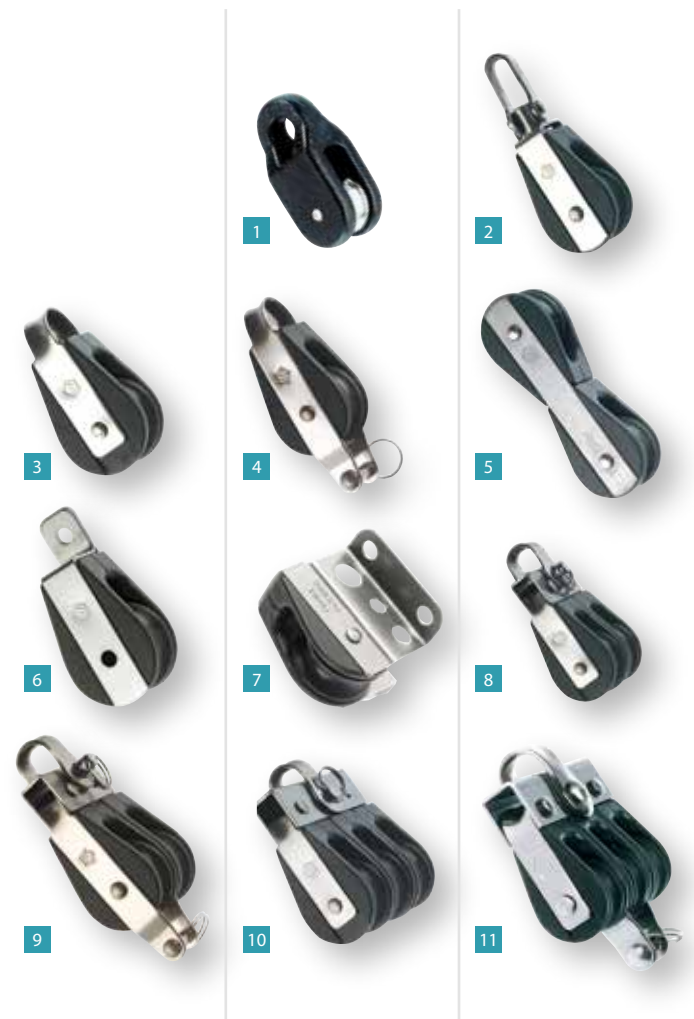

Blocks

plain bearing and ball bearing

SHEAVE DIA 35

+ BENEFITS

- Large range
- Universal head allows wide choice of fastenings
- High resistance under high loads
- Modern design
- Sheave protected by cheeks
- Load bearing stainless steel shaft
- Adjustable cam cleats
- For following rope diameters: 8, 9, 10, 12 and 14 mm



SHEAVE DIA 35

rope size 8 to 9 mm, forged shackle 5 mm

N°	Part plain bear.	Part ball bear.	Description	Height mm	Width mm	Thick. mm	W.L. Kg	B.L. Kg	Weight Kg
SINGLE BLOCKS									
1	62105	72105	Swivel head	84	37	23	320	900	0.071
2	62106	72106	Swivel head with becket	101	37	23	320	900	0.079
3	62108	72108	Swivel head with becket and cam	101	64	45	200	900	0.118
5	62117	72117	Fixed head with clevis	72	37	23	320	500	0.055
6	62113	72113	Fixed eye	65	37	23	320	900	0.051
7	62120	72120	Cheek block, bolts 6 mm dia	52	37	20	320	900	0.044
10	62121	72121	Upright block	42	46	40	320	900	0.053
11	62122	-	Reefing block	60	58	40	320	900	0.103
8	62131	72131	Swivel snap hook	102	37	23	200	400	0.076
DOUBLE BLOCKS									
12	62205	72205	Swivel head	84	37	40	480	900	0.119
13	62206	72206	Swivel head with becket	101	37	40	480	900	0.128
TRIPLE BLOCKS									
15	62305	72305	Swivel head	84	37	58	560	1000	0.149
16	62306	72306	Swivel head with becket	101	37	58	560	1000	0.157
17	62308	72308	Swivel head with becket and cam	101	66	60	200	1000	0.208
FIDDLE BLOCKS									
18	62405	72405	Swivel head	107	37	23	320	900	0.086
20	62408	72408	Swivel head with becket and cam	124	64	45	200	900	0.138

Blocks plain bearing and ball bearing

SHEAVE DIA 45



SHEAVE DIA 45

rope size 10 mm, forged shackle 5 mm

N°	Part plain bear.	Part ball bear.	Description	Height mm	Width mm	Thick. mm	W.L. Kg	B.L. Kg	Weight Kg
SINGLE BLOCKS									
1	63105	73105	Swivel head	97	49	26	400	900	0.105
2	63106	73106	Swivel head with becket	117	49	26	400	900	0.120
3	63108	73108	Swivel head with becket and cam	117	86	61	280	900	0.211
4	63109	-	Swivel with clevis	98	49	26	400	700	0.101
4	63117	73117	Fixed head with clevis	87	49	26	400	700	0.089
5	63113	73113	Fixed eye	78	49	26	400	900	0.083
8	63118	73118	Webbing D ring	93	49	26	400	900	0.108
6	63120	73120	Cheek block, bolts 6 mm dia	65	49	23	400	900	0.073
DOUBLE BLOCKS									
12	63205	73205	Swivel head	97	49	46	480	1000	0.184
13	63206	73206	Swivel head with becket	117	49	46	480	1000	0.199
14	63207	73207	Swivel snap shackle	110	49	46	480	1000	0.208
TRIPLE BLOCKS									
15	63305	73305	Swivel head	97	49	67	560	1000	0.243
16	63306	73306	Swivel head with becket	117	49	67	560	1000	0.257
17	63308	73308	Swivel head with becket and cam	117	87	72	360	1000	0.357
FIDDLE BLOCKS									
18	63405	73405	Swivel head	130	49	26	560	1000	0.147
19	63406	73406	Swivel head with becket	150	49	26	560	1000	0.156
21	63407	73407	Swivel head with cam	130	86	61	360	1000	0.240
20	63408	73408	Swivel head with becket and cam	150	86	61	360	1000	0.249
22	63435	73435	Swivel snap shackle	143	49	26	560	1000	0.171
23	63438	73438	Swivelling snap shackle with becket and cam	163	86	61	360	1000	0.273

WL: working load - BL: breaking load



15



16



17



18



19



20



21



22



23

Blocks

plain bearing and ball bearing

SHEAVE 55 AND 70

+ BENEFITS

- Large range
- Universal head allows wide choice of fastenings
- High resistance under high loads
- Modern design
- Sheave protected by cheeks
- Load bearing stainless steel shaft
- Adjustable cam cleats
- For following rope diameters: 8, 9, 10, 12 and 14 mm

SHEAVE DIA 55

rope size 12 mm, forged shackle 6 mm

N°	Part plain bear.	Part ball bear.	Description	Height mm	Width mm	Thick. mm	W.L. Kg	B.L. Kg	Weight Kg
SINGLE BLOCKS									
1	64105	74105	Swivel head	119	63	29	720	1500	0.179
2	64106	74106	Swivel head with becket	144	63	29	720	1500	0.200
3	64108	74108	Swivel head with becket and cam	144	95	61	480	1500	0.302
8	64109	74109	Swivel with clevis	113	63	29	640	1000	0.159
9	64110	74110	Swivel with clevis and becket	138	63	29	640	1000	0.185
4	64117	74117	Fixed head with clevis	107	63	29	720	1200	0.157
5	64113	74113	Fixed eye	98	63	29	720	1500	0.138
6	64118	74118	Webbing D ring	110	63	29	720	1500	0.166
7	64130	74130	Swivelling snap shackle	126	63	29	720	1500	0.184
10	64120	74120	Cheek block, bolts 6 mm dia	81	63	26	720	1500	0.123

DOUBLE BLOCKS									
11	64205	74205	Swivel head	119	63	52	800	1500	0.315
12	64206	74206	Swivel head with becket	144	63	52	800	1500	0.337

TRIPLE BLOCKS									
13	64305	74305	Swivel head	119	63	75	880	1500	0.410
14	64306	74306	Swivel head with becket	144	63	75	880	1500	0.429
15	64308	74308	Swivel head with becket and cam	144	97	81	480	1500	0.550

FIDDLE BLOCKS									
16	64405	74405	Swivel head	160	63	29	800	1500	0.247
17	64406	74406	Swivel head with becket	186	63	29	800	1500	0.270
18	64408	74408	Swivel head with becket and cam	186	95	61	480	1500	0.374
19	64435	74435	Swivelling snap shackle	167	63	29	800	1500	0.253
20	64438	74438	Swivelling snap shackle with becket and cam	193	95	61	480	1500	0.380

WL: working load - BL: breaking load





SHEAVE DIA 70

rope size 14 mm, forged shackle 8 mm

N°	Part plain bear.	Part ball bear.	Description	Height mm	Width mm	Thick. mm	W.L. Kg	B.L. Kg	Weight Kg
SINGLE BLOCKS									
1	65105	75105	Swivel head	153	80	39	1200	2700	0.367
2	65106	75106	Swivel head with becket	183	80	39	1200	2700	0.416
3	65108	75108	Swivel head with becket and cam	183	120	80	480	2700	0.599
8	65109	75109	Swivel with clevis	137	80	39	800	1500	0.357
4	65117	75117	Fixed head with clevis	132	80	39	1200	2000	0.320
7	65130	75130	Swivelling snap shackle	162	80	39	1200	2700	0.395
10	65120	75120	Cheek block, bolts 8 mm dia	103	80	34	1200	2700	0.294
DOUBLE BLOCKS									
11	65205	75205	Swivel head	153	80	68	1440	2700	0.653
12	65206	75206	Swivel head with becket	183	80	68	1440	2700	0.714
TRIPLE BLOCKS									
13	65305	75305	Swivel head	153	80	97	1600	2700	0.895
14	65306	75306	Swivel head with becket	183	80	97	1600	2700	0.941
15	65308	75308	Swivel head with becket and cam	183	123	101	480	2700	1.139
FIDDLE BLOCKS									
16	65405	75405	Swivel head	204	80	39	1440	2700	0.518
17	65406	75406	Swivel head with becket	236	80	39	1440	2700	0.570
18	65408	75408	Swivel head with becket and cam	236	120	80	480	2700	0.748
19	65435	75435	Swivelling snap shackle	213	80	39	1440	2700	0.570
20	65438	75438	Swivelling snap shackle with becket and cam	245	120	80	480	2700	0.790

WL: working load - BL: breaking load

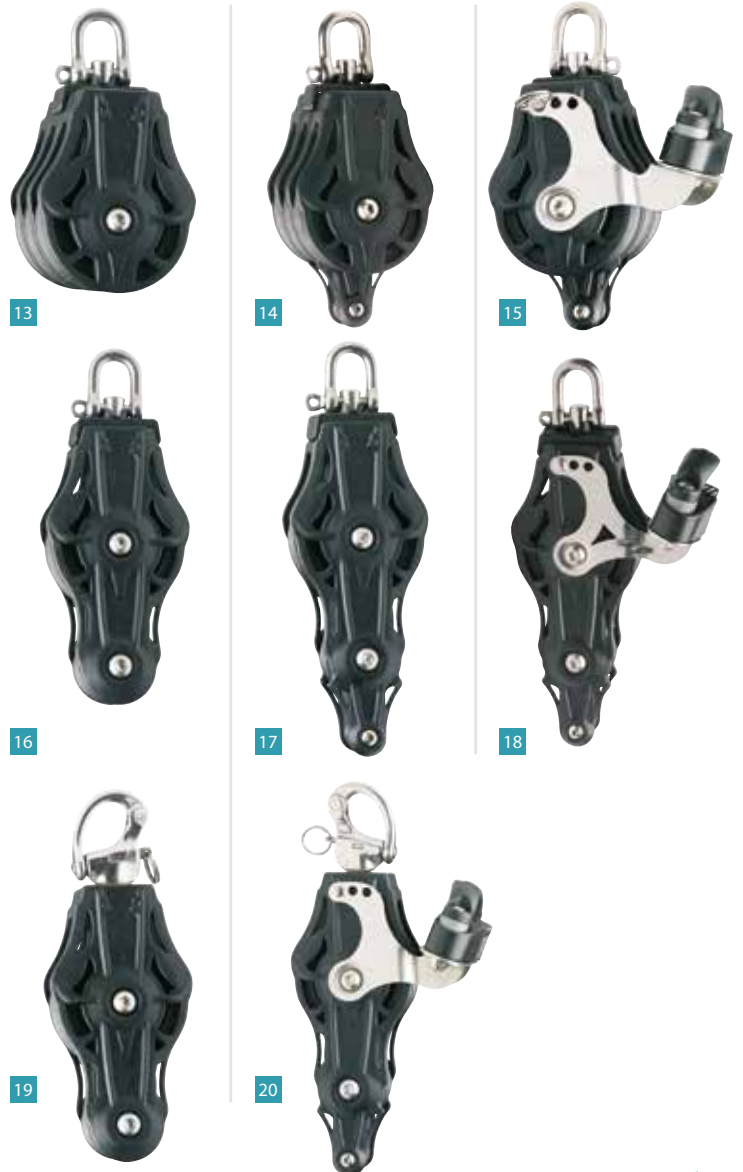

Roller Blocks*

SHEAVE 30, 40, 50



Roller blocks

Wichard roller bearing blocks are designed to be simple, reliable and long-lasting. They are ideal for dynamic running rigging that is subject to heavy loads (mainsail tackle, mastfoot block, etc.).



1



2



3



4



5



6



7



8



9



10



11



12



13



14

N°	Part #	Description	Height mm	Width mm	Thick mm	W.L. Kg	B.L. Kg	Weight Kg
SINGLE BLOCKS: SHEAVE 30 FOR ROPE SIZE 6 TO 10 MM - SHACKLE 4 MM								
1	90105	Swivel head	63	31	20	144	700	0,048
2	90106	Swivel head with becket	80	31	20	144	700	0,054
SINGLE BLOCKS: SHEAVE 40 FOR ROPE SIZE 8 TO 10 MM - SHACKLE 5 MM								
1	93105	Swivel head	80	42	27	320	900	0,104
2	93106	Swivel head with becket	96	42	27	320	900	0,100
4	93120	Cheeks block - bolts M5	67	42	25	320	900	0,106
DOUBLE BLOCK: SHEAVE 40 FOR ROPE SIZE 8 TO 10 MM - SHACKLE 5 MM								
5	93205	Swivel head	80	42	47	320	1000	0,128
SINGLE BLOCKS: SHEAVE 50 FOR ROPE SIZE 8 TO 10 MM - SHACKLE 6 MM								
1	94105	Swivel head	93	52	28	480	1500	0,138
2	94106	Swivel head with becket	113	52	28	480	1500	0,124
3	94108	Swivel head with becket and cam	113	102	60	480	1500	0,248
4	94120	Cheeks block - bolts M5	78	52	25	480	1500	0,152
DOUBLE BLOCKS: SHEAVE 50 FOR ROPE SIZE 8 TO 10 MM - SHACKLE 6 MM								
5	94205	Swivel head	93	52	48	640	1600	0,210
6	94206	Swivel head with becket	113	52	48	640	1600	0,226
TRIPLE BLOCKS: SHEAVE 50 FOR ROPE SIZE 8 TO 10 MM - SHACKLE 6 MM								
7	94305	Swivel head	93	52	68	640	1600	0,284
8	94306	Swivel head with becket	113	52	68	640	1600	0,292
9	94307	Swivel head and cam	93	102	60	480	1600	0,380
10	94308	Swivel head with becket and cam	113	102	60	480	1600	0,392
FIDDLE BLOCKS: SHEAVE 50 FOR ROPE SIZE 8 TO 10 MM - SHACKLE 6 MM								
11	94405	Swivel head	130	52	28	480	1500	0,174
12	94406	Swivel head with becket	150	52	28	480	1500	0,182
13	94407	Swivel head and cam	130	102	60	480	1500	0,278
14	94408	Swivel head with becket and cam	150	102	60	480	1500	0,284

* SPECIFIC PARTS: AVAILABILITY UPON REQUEST

Roller Blocks*

SHEAVE 65, 80

COMPONENTS: ROLLER BEARING BLOCKS

1. Forged stainless-steel shackle (HR s-steel for HR models).
2. Stainless-steel swivel head
3. 316L stainless-steel bolt
4. Aluminium cheeks (hard coat anodization)
5. Delrin® roller bearings (Torlon® for HR models).
6. Centring bush for lateral loads
7. Stainless-steel circlip
8. Hard anodized aluminium sheave (+ Teflon for HR models).
9. Hard anodized aluminium hollow pin (+ Teflon for HR models).

N°	Part #	Description	Height mm	Width mm	Thick. mm	W.L. Kg	B.L. Kg	Weight Kg
SINGLE BLOCKS - SHEAVE 65 FOR ROPE SIZE 8 TO 12 MM - SHACKLE 8 MM								
1	95105	Swivel head	112	68	30	600	1800	0,218
2	95106	Swivel head with becket	134	68	30	600	1800	0,232
3	95108	Swivel head with becket and cam	134	118	60	480	1800	0,338
4	95120	Cheeks block - bolts M5	94	68	26	600	1800	0,200
DOUBLE BLOCKS - SHEAVE 65 FOR ROPE SIZE 8 TO 12 MM - SHACKLE 8 MM								
5	95205	Swivel head	112	68	50	720	1800	0,278
6	95206	Swivel head with becket	134	68	50	720	1800	0,282
7	95220	Cheeks block - bolts M5	94	68	48	520	1800	0,314
TRIPLE BLOCKS - SHEAVE 65 FOR ROPE SIZE 8 TO 12 MM - SHACKLE 8 MM								
8	95305	Swivel head	112	68	70	720	1800	0,418
9	95306	Swivel head with becket	134	68	70	720	1800	0,422
10	95307	Swivel head and cam	112	118	60	480	1800	0,514
11	95308	Swivel head with becket and cam	134	118	60	480	1800	0,534
FIDDLE BLOCKS - SHEAVE 65 FOR ROPE SIZE 8 TO 12 MM - SHACKLE 8 MM								
12	95405	Swivel head	158	68	30	600	1800	0,268
13	95406	Swivel head with becket	180	68	30	600	1800	0,280
14	95310	Swivel head triple sheave	158	68	70	600	1800	0,466
15	95407	Swivel head and cam	158	118	60	480	1800	0,374
16	95408	Swivel head with becket and cam	180	118	60	480	1800	0,382
SINGLE BLOCKS - SHEAVE 80 FOR ROPE SIZE 8 TO 12 MM - SHACKLE 8 MM								
1	96105	Swivel head	128	83	27	1000	2050	0,280
2	96106	Swivel head with becket	154	83	27	1000	2050	0,294
4	96120	Cheeks block - bolts M5	110	83	25	1000	2050	0,268
DOUBLE BLOCKS - SHEAVE 80 FOR ROPE SIZE 8 TO 12 MM - SHACKLE 8 MM								
5	96205	Swivel head	128	83	47	720	2050	0,374
7	96220	Cheeks block - bolts M5	110	83	44	800	2050	0,430



* SPECIFIC PARTS: AVAILABILITY UPON REQUEST

HR Roller Blocks*

SHEAVE 65, 80, 100, 125, 160, 200, 240



N°	Part #	Description	Ø shackle mm	Height mm	Width mm	Thick. mm	W.L. Kg	B.L. Kg	Weight Kg
SINGLE BLOCKS: ALUMINIUM SHEAVE 65 - ROPE SIZE 8 TO 12 MM									
1	41105	Swivel head	6	106	67	31	1000	2700	0,198
2	41106	Swivel head with becket	8	132	67	31	1000	2700	0,280
DOUBLE BLOCK: ALUMINIUM SHEAVE 65 - ROPE SIZE 8 TO 12 MM									
4	41205	Swivel head	10	125	67	54	1000	2700	0,478
SINGLE BLOCKS: ALUMINIUM SHEAVE 80 - ROPE SIZE 12 TO 14 MM									
1	42105	Swivel head	8	133	83	35	1600	4000	0,396
2	42106	Swivel head with becket	10	165	83	35	1600	4000	0,484
3	42120	Cheek block - bolts M5	-	112	83	33	1600	4000	0,488
DOUBLE BLOCKS: ALUMINIUM SHEAVE 80 - ROPE SIZE 12 TO 14 MM									
4	42205	Swivel head	12	155	83	57	1600	4000	0,868
5	42220	Cheek block - bolts M8	-	112	83	55	1600	4000	0,728
SINGLE BLOCKS: ALUMINIUM SHEAVE 100 - ROPE SIZE 16 TO 18 MM									
1	43105	Swivel head	10	165	104	39	2000	5000	0,692
2	43106	Swivel head with becket	12	200	104	39	2000	5000	0,904
3	43120	Cheek block - bolts M10	-	142	104	36	2000	5000	0,900
DOUBLE BLOCKS: ALUMINIUM SHEAVE 100 - ROPE SIZE 16 TO 18 MM									
4	43205	Swivel head	14	195	104	68	2000	5000	1,648
5	43220	Cheek block - bolts M10	-	142	104	65	2000	5000	1,386
SINGLE BLOCKS: ALUMINIUM SHEAVE 125 - ROPE SIZE 18 TO 20 MM									
1	44105	Swivel head	12	204	130	45	4000	9500	1,314
2	44106	Swivel head with becket	14	250	130	45	4000	9500	1,514
3	44120	Cheek block - bolts M12	-	177	130	42	4000	9500	1,464
DOUBLE BLOCK: ALUMINIUM SHEAVE 125 - ROPE SIZE 18 TO 20 MM									
5	44220	Cheek block - bolts M12	-	177	130	73	4000	9500	2,240
SINGLE BLOCKS: ALUMINIUM SHEAVE 160 - ROPE SIZE 20 TO 24 MM									
1	45105	Swivel head	14	255	165	51	5000	11000	2,768
2	45106	Swivel head with becket	16	315	165	51	5000	11000	2,940
3	45120	Cheek block - bolts M16	-	223	165	49	5000	11000	2,962
DOUBLE BLOCK: ALUMINIUM SHEAVE 160 - ROPE SIZE 20 TO 24 MM									
5	45220	Cheek block - bolts M16	-	223	165	84	5000	11000	4,516
SINGLE BLOCKS: ALUMINIUM SHEAVE 200 - ROPE SIZE 24 TO 26 MM									
1	46105	Swivel head	20	325	209	61	8000	20000	4,804
2	46106	Swivel head with becket	20	410	209	61	8000	20000	5,026
3	46120	Cheek block - bolts M16	-	280	209	58	8000	20000	4,722
DOUBLE BLOCK: ALUMINIUM SHEAVE 200 - ROPE SIZE 24 TO 26 MM									
5	46220	Cheek block - bolts M16	-	280	209	99	8000	20000	7,752
SINGLE BLOCKS: ALUMINIUM SHEAVE 240 - ROPE SIZE 26 TO 30 MM									
1	47105	Swivel head	24	380	245	69	12000	28000	7,320
3	47120	Cheek block - bolts M20	-	325	240	65	12000	28000	6,994
DOUBLE BLOCK: ALUMINIUM SHEAVE 240 - ROPE SIZE 26 TO 30 MM									
5	47220	Cheek block - bolts M20	-	325	240	130	12000	28000	10,950

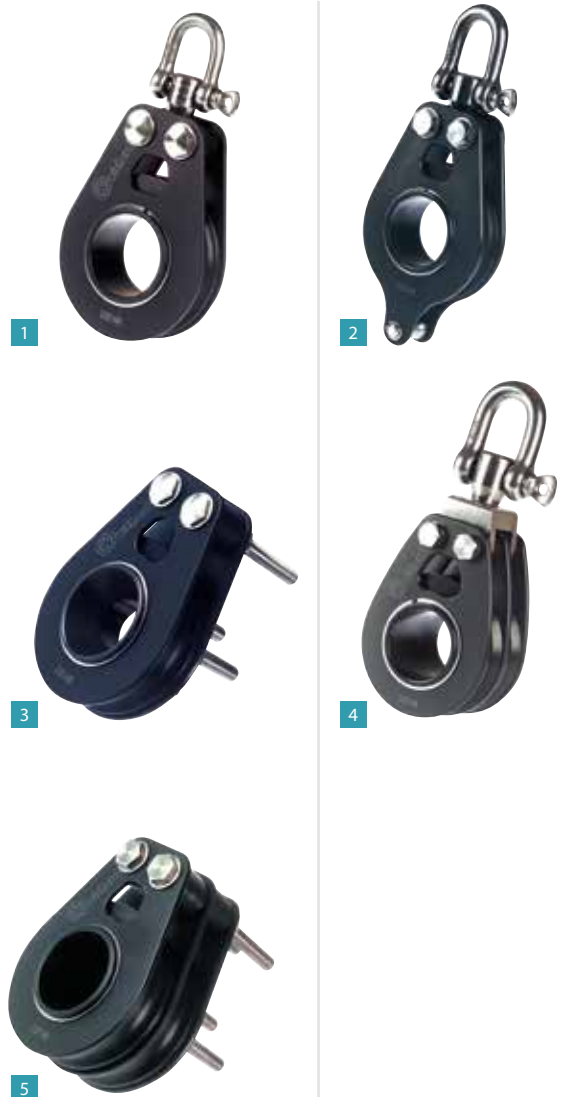

* SPECIFIC PARTS: AVAILABILITY UPON REQUEST



Soft snatch blocks

- 4 models available from 2T to 7T
- Various applications on board
- High resistance and lightness
- Easy and fast installation thanks to Dyneema® loop
- Fast and safe opening / closing with the Velcro® strap
- Modern design
- Sheave protection by the cheeks
- Material: anodised aluminium (cheeks & sheave), Dyneema® loop, stainless steel dogbone

APPLICATIONS :

- Flying sail furler terminals (2:1 gennaker halyard)
- Main sail (2:1)
- Barber-hauler
- Sheets
- ...

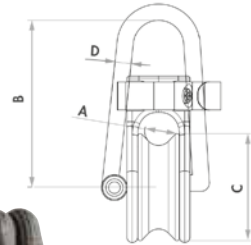

N°	Part #	Description	A: Rope dia mm	B mm	C: sheave dia mm	Loop dia mm	W.L. Kg	B.L. Kg	Weight Kg
SOFT SNATCH BLOCK									
	36010	For 10 mm rope	10	59	41	5	2000	4000	0.099
	36020	For 12 mm rope	12	64	46	6	3000	6000	0.141
3	36030	For 16 mm rope	16	79	55	8	4500	9000	0.249
	36040	For 20 mm rop	20	90	70	10	7000	14000	0.461



1

Snatch blocks with snap shackle

Fitted to a pad eye or toe rail Wichard snatch blocks are highly useful for taking up a rope that is already reeved. The elastomer moulded cheeks make them shock and scratch-resistant. Each one is fitted with a snap shackle which allows them to move freely in any position. With its forged high-resistance stainless steel arm, the closing system is very strong. It can be opened very easily by pulling on the central plunger pin, as you would do with a normal snap shackle.



2

N°	Part #	Description	Height mm	Width mm	Thick. mm	W.L. Kg	B.L. Kg	Weight Kg
SNATCH BLOCKS								
1	34500	Max. 12 mm diam. rope	145	59	43	720	1300	0.254
1	35500	Max. 18 mm diam. rope	155	59	49	1200	2500	0.414

Stainless steel snatch block

This stainless steel snatch block can be used for any application. The design makes its positioning easier. The all stainless steel construction is a guarantee of safety and reliability.

STAINLESS STEEL SNATCH BLOCK

rope size 6 mm

N°	Part #	Description	Height mm	Width mm	Thick. mm	W.L. Kg	B.L. Kg	Weight Kg
SINGLE BLOCKS								
2	31031	Max rope size 6 mm	127	50	17.5	200	300	0.124



3

WL: working load - BL: breaking load

Deck accessories

N°	Part #	Description	Weight Kg
----	--------	-------------	-----------

SWIVEL BASE			
1	30101	Mainsheet swivel base - ball bearing- rope size 12 mm	0.308
2	30103	Swivel cleat base - rope size 12 mm	0.160
3	30105	Swivel cleat base - rope size 12 mm	0.178

N°	Part #	For rope Ø / mm	Fastener spacing mm	Weight Kg
Cam cleats				
4	30006	8	26	0.017
	30012	12	38	0.044
	30016	16	52	0.068

STAND UP SPRINGS		
5	32530	Stand up spring without collar for sheaves dia 18 & 25 mm
	32540	Stand up spring with collar for sheaves dia 35 & 45 mm
	32550	Stand up spring with collar for sheaves dia 55 & 70 mm

N°	Part #	Description	For blocks	Clevis Ø mm	Ø Pin mm	Weight Kg
----	--------	-------------	------------	-------------	----------	-----------

CLEVIS ADAPTOR						
6	32570	Swivel, clevis adaptor	Sheave 35&45	8	5	0.024
	32571	Swivel, clevis adaptor	Sheave 55	10	6	0.023

MAST STEP ADAPTOR			
7	32580	Mast step adaptor for Part # 63117 & 73117 - Ø drilling: 5.2 mm	0.034
	32581	Mast step adaptor for Part # 64117 & 74117 - Ø drilling: 8.2 mm	0.042

N°	Part #	Height mm	Fastener spacing mm	For rope Ø mm	Weight Kg
SADDLES STAINLESS STEEL					
8	30026	11	26	8	0.003
	30038	15	38	12	0.010
	30052	21	52	16	0.016

SADDLES POM					
9	30126	14,5	26	8	0.002
	30138	19	38	12	0.007
	30152	22,5	52	16	0.009

N°	Part #	Description	Ø Sheave mm	Thickness mm	Ø Pin mm	Ø rope mm
----	--------	-------------	-------------	--------------	----------	-----------

PLAIN BEARING SHEAVES						
10	60081	Sheave	18	8,5	6	4
	60082	Sheave	25	10,5	6	6
	60083	Sheave	35	11,5	10	8
	60084	Sheave	45	13	10	10
	60085	Sheave	55	15	10	12
	60086	Sheave	70	19	14	14
	60087	Sheave	80	22	17	18

SHEAVES WITH CAPTIVE BALLS						
11	80085	Captive balls	55	15	10	12
	80086	Captive balls	70	19	14	14
	80088	Captive balls	32	15	10	10
	80089	Captive balls	42	19	14	18

DECK ORGANIZERS: BALL BEARINGS SHEAVES (STACKED)

N°	Part #	Sheaves	Ø Sheave mm	Ø Rope mm	Length mm	Width mm	Thickness mm	Fastener mm	Ø Pin mm	Weight Kg
12	81512	2	32	4 to 12	95	35	22	43	6	0.070
13	81513	3	32	4 to 12	140	35	22	43	6	0.106
14	81514	4	32	4 to 12	180	35	22	43	6	0.140
12	81522	2	42	8 to 16	125	45	28	57	8	0.156
13	81523	3	42	8 to 16	185	45	28	57	8	0.231
14	81524	4	42	8 to 16	240	45	28	57	8	0.305

WL: working load - BL: breaking load

For sport boats or dinghies, swivel bases enable the boat's fittings to be optimised. They are manufactured according to Wichard tradition of quality, and form part of the original equipment on many modern designs. Their dimensions and the adjustable orientation of the cam cleats, mean they can be installed on your boat without any modifications.





Safety

Tethers, Gyb'Easy the Wichard boom brake,
Lyf'safe, the jacklines kit

Wichard designs cutting-edge technology products whose
main function is to provide enhanced safety.

They are robust, easy to use and will bring
you satisfaction.



Boom brake

Gyb'Easy



Gybing remains one of the most challenging operations on a sailing boat even for experienced sailors and can possibly generate injuries and material damage. An efficient and safe solution: Gyb'Easy the Wichard boom brake.

Concept

Thanks to the frictions of the specific line passing over the boom break, the boom is allowed to gybe smoothly. With Gyb'Easy, the gybe operations are safer, potential accidents reduced and without jerks.

Settings of Gyb'Easy

The adjustment of Gyb'Easy is made thanks to the tension of the specialized line. 3 different positions exist for a perfect adaptation to the mainsail and wind conditions (see pictures).

The more the line passes over the openings, the more the friction is increased and hence the brake efficiency.

An easy installation on all kinds of boats

The installation only takes a few minutes: a shackle is attached onto one of the boom eye straps. In order to fit with all deck configurations, two different fittings can be implemented. The boom brake can be installed either on modern boats or old gaffers.

Features:

- Can be used on mainsail areas below 40 sqm.
- Material: aluminium with anodisation.
- Weight: 0.600 kg.
- Part #: 7150 (delivered with rope and shackle). Part # 1244
- Rope available in two lengths 16 und 25 m

Setting 1

Setting 2

Setting 3



Visit our **Wichard Sailing** You Tube channel and download the **Gyb'Easy** video

Jacklines

Lyf'Safe

The Wichard jackline

Universal, Ready-to-use, Reflective

Either sailing solo or fully crewed, operating on the foredeck in most conditions require extra attention and safety precautions.

Lyf'Safe by Wichard is a complete jackline kit allowing safer operations and offering added value to the crew.

Adaptable and universal

Lyf'Safe can be tailored to the length of the boat (using the adjuster) and can be fitted on to most deck fastenings (padeyes, pulpit/pushpit, cleats).

Ready-to-use

Easy to install, Lyf'Safe does not require additional fastening components such as shackles.

Reflective

Thanks to its reflective stripe and photoluminescent casing, Lyf'Safe can be easily identified when sailing at night.

Locking system of the webbing

The adjuster casing prevents any accidental adjustment or release of the webbing.

Resistant and anti-chaffing

The anti-abrasion edges to the webbing prevent early wear and fraying, the soft elastomer casing isolates the deck, eliminating noise and vibrations.

Aesthetic

Lyf'Safe is an elegant solution suiting most modern deck designs.

4 models available :

- Part # 7051 : length 8,5m.
- Part # 7052 : length 11m.
- Part # 7053 : length 14m.
- Part # 7054 : length 16m.

Components of Lyf'Safe :

- 2 reflective webbings.
- 2 forged adjusters.
- 2 photoluminescent casings.
- 1 set containing 8 screws.
- 1 installation manual.



Spare parts
available



Visit our **Wichard Sailing**
You Tube channel and download
the **Lyf'Safe** video

ProLine

When it comes to safety, compromise is not an option. That is why Wichard has developed a new generation of tethers to ensure maximum safety and ease of use thanks to some innovative new features.

Maximum safety

- ErgoLockSystem (patented): automatically closes and locks the snap hook
- Locking indicator
- Retro-reflective webbing, visible at night
- Overload indicator (as per ISAF offshore special regulations)

Uniquely easy to use

- Easy opening snap hook
- V-Nose (patented): special tip makes hooking and unhooking easy with one hand
- Wide opening snap hook (26 mm)
- Compact light tether

+ BENEFITS

- 4 models available
- Compliance with ISO 12401:2009 and ISAF regulations (OSR)
- Overload indicator with shock absorber on all models

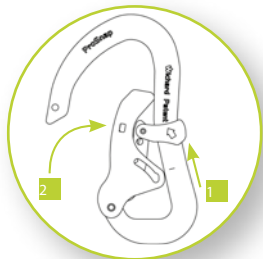

ProSnap: double action safety hook



Wide opening



V-Nose

ProSnap Safety snap hook

ProLine Webbing

ErgoLockSystem

EcoLogic

SmartLoop

Part #	Description	Length Max	Weight Kg	
7031	2 ProSnap snap hooks Elastic webbing incl. overload indicator	2 m	0.305	
7032	1 ProSnap hook Flat webbing incl. overload indicator	0.80 m	0.150	
7033	1 ProSnap hook Elastic webbing incl. overload indicator	1.40 m	0.175	
7034	3 ProSnap snap hooks Elastic + flat webbing incl. overload indicator	2 m + 1 m	0.455	



Visit our **Wichard Sailing** You Tube channel and download the **Proline** video

PPE:TETHERS

ProLine'R

Releasable tether under load

The ProLine'R range is equipped with a forged stainless steel snap shackle meaning they can be released under load in emergency situations (man overboard, capsizing, etc.). The ProLine'R have all the features of the Proline range: ergonomic design, wide opening, high levels of safety, lightweight structure and replaceable webbing.



Part #	Description	Length Max	Weight Kg
7061	1 ProSnap snap hook + 1 quick opening snap hook part # 2299 - elastic webbing with overload indicator	2 m	0.320
7064	2 ProSnap snap hooks + 1 quick opening snap shackle part # 2299 - elastic webbing + flat webbing - with overload indicator	2 m + 1 m	0.474

+ BENEFITS

- 2 models available
- Snap shackle on the harness can be released
- Overload indicator (OSR-Isaf) with in-built shock absorber
- CE marking

Accessories

Exclusive feature: EcoLogic

Removable snap hook lets you increase the lifespan of the product by replacing the webbing only. Our exclusive EcoLogic feature makes ProLine a budget-friendly range!

Exclusive feature: SmartLoop

Product can adapt to suit all needs and users. SmartLoop lets you:

- turn a single webbing tether into a double webbing tether (see fig. A)
- turn a double webbing tether into two single webbing tethers (see fig. B)

Part #	Description
7041	Proline webbing for Proline part # 7031
7042	Proline webbing for Proline part # 7032
7043	Proline webbing for Proline part # 7033
7071	Proline'R webbing for Proline'R part #7061
7072	Proline'R webbing for Proline'R part #7064

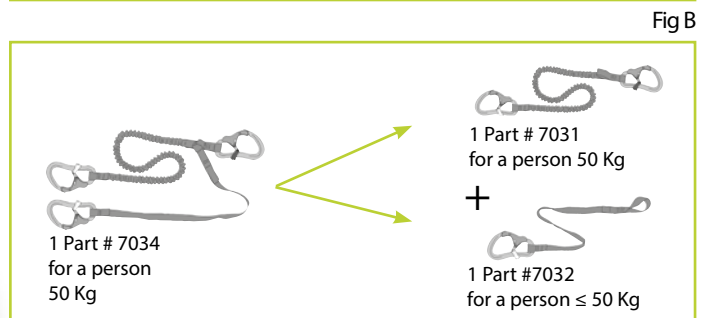
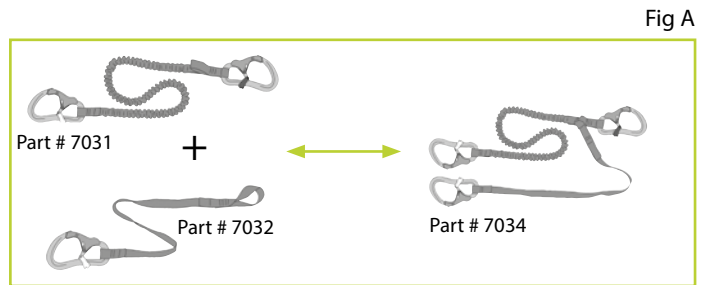
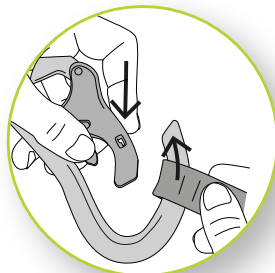

INFORMATION ABOUT THE ISO 12401:2009 STANDARD

For the amateur sailor safety, the standard demands:

- Self-locking carabine hooks
- A possible unhooking from the harness side (for people above 50Kgs)
- An impossible unhooking from the harness side for people below 50Kgs (children)

PPE : TETHERS

+ BENEFITS

- Large range of tethers
- Compliant with ISO 12401:2009
- Available with double action safety hooks (phosphorescent) or carabiner hooks
- Available with flat or elastic tethers
- Ensures safety during movements on deck
- Designed and made in France

N°	Part #	Description	Weight kg
TETHER WITH DOUBLE ACTION SAFETY HOOKS			
1	7005	Elastic harness tether from 1 to 2 m, with double action safety hooks.	0.398
2	7006	Elastic harness tether - 1 m fixed line, the other retracts from 2 to 1 m with three double action safety hooks.	0.582
3	7015	Harness tether, 2 meter long with two double action safety hooks.	0.392
4	7016	Harness tether, flat webbing (25mm), 2 meter long with one action safety hook.	0.210
TETHERS WITH STAINLESS STEEL CARBINE HOOKS			
5	7001	Elastic harness tether from 1 to 2 m, with two stainless steel carbine hooks.	0.418



+ BENEFITS

- Fitted with a quick opening snap shackle on the harness side
- With an overload indicator
- 2 models available
- Designed and made in France

N°	Part #	Description	Weight kg
TETHERS RELEASABLE UNDER LOAD			
8	7007	Elastic harness tether. Retracts from 2 to 1 meter, with overload indicator, one double action safety hook and one quick opening snap shackle.	0.348
9	7008	Elastic tether, 1 meter fixed line, the other retracts from 2 to 1 meter, with overload indicator, two double action safety hooks and one quick opening snap shackle.	0.480





PROTECTING THE ENVIRONMENT

At Wichard, we don't simply pay lip service to environmental protection.

When manufacturing our knives, we do everything practical to contribute to protecting nature on a daily basis:

- Manufacturing our knives locally and nationally.
- Sourcing materials nationally or in Europe.
- Reducing components.
- The use of recyclable materials (for example paper from sustainably managed forests).
- Building awareness among our suppliers of the need to preserve the environment and verifying that suitable measures are being taken.

Knives

The Wichard spirit

Ever since it was founded in 1919, Wichard has produced its knives in Thiers, the traditional home of knife-making in France.

As manufacturers specialising in marine hardware, we have designed our new knife ranges to provide you with Wichard's proven strength and reliability in all circumstances during your nautical activities.

A Wichard knife is a must-have tool offering outstanding cutting performance as well as being easy to use, safe and long-lasting.

Usage

All Offshore and Aquaterra knives are fitted with a locking blade.

The shackle opener - marlinspike on the Offshore model can also be locked in the open position for improved comfort during use.

- To unlock the blade, simply press the back of the knife.
- On the Offshore models, the cut-out section on the blade allows you to open the blade one-handed. Do not use this cut-out for unshackling.

Maintenance & storage

Here are a few handy tips to ensure optimal operation and a long life for your Wichard knife:

- Wipe your knife after each use or rinse it in clear water.
- Never put your knife in the dishwasher.
- Allow it to dry with the blade open to facilitate the evaporation of water.
- After several rinses, you can apply 3 in 1 oil to the mechanism.

OFFSHORE

SAILING KNIFE STAYS SHARP IN ALL CONDITIONS

Designed for sailing and for highly demanding skippers, the «Offshore» knife offers a range of essential functions on-board a boat: Cutting quality, night visibility, locking blade, one-handed opening, corrosion resistance, mechanical resistance...

Its serrated blade enables you to easily cut all types of modern ropes including Dyneema®. The shackle opener - marlinspike version is also a vital tool on-board a sailing boat. Each Offshore knife is equipped with an adjustable wrist strap to avoid losing your knife when using it.



Serrated blade



Stainless steel blade (N680) for an outstanding corrosion resistance

High resistance handle
Extreme temperatures:
-76°F +148°F



Soft grip



Remarkable cutting power



Single hand opening



Glow in the dark
(depending on model)



Safety locking blade



Fastening point for wrist loop



Blade
shackle key
- spike

Part # 10122 /
10126 / 10129



3 colors available

OFFSHORE

Range Part #	Single blade	Blade-shackle key - spike
Part # color fluorescent	10112	10122
Part # color blue	10116	10126
Part # color orange	10119	10129
	✓	✓
	✓	✓
	✓	✓
	✓	✓
	✓	✓
	✗	(Ø12 mm - 15/32)
	✗	✓
	✗	✓
	7 11/16 / 4 17/32 - 195 mm / 115 mm	
	3 5/32 / 1 25/32 - 80 mm / 45 mm	
	★★★★☆	★★★★☆
	★★★★☆	★★★★☆
	Part # 10112	Part # 10122
Stainless steel grade	N680	N680
	66 g / 2.32 oz	85 gr / 2.99 oz



OFFSHORE RESCUE

Specifically developed for rescue operations and extreme sports (offshore racing, sport catamaran, white water sport, etc.). Careful material selection (N680 stainless steel grade) brings high corrosion resistance, outstanding cutting power and high robustness.



CUTTING POWER
& CORROSION RESISTANCE

RESCUE KNIFE - FIXED BLADE



Locking trigger

OFFSHORE RESCUE			
	Fluorescent serrated blade	Red serrated blade	Black Plain blade
Part #	10192	10194	10195
	✓	✓	✗
		✓	
		✓	
		✓	
		(Ø12 mm - 15/32)	
	✓	190 mm / 7 ^{31/64}	
		72 mm / 2 ^{53/64}	
		★★★★★	
		★★★★★	
	✓		✗
Stainless steel grade	N680		
	119g / 4.20 oz		

The secured sheath enables the knife to be positioned in all situations. The sheath offers many fastening points : personally on the sailor (lifejacket, arm, leg), on various locations (cockpit, steering wheel, mast foot, trampoline, catamaran cross beams).

RESCUE LINE CUTTER

The line cutter enables the cutting of small diameter lines (Dyneema lines, nets, webbings, kite lines i.e..). Thanks to a specific surface treatment, the line cutter is specially hardened (70 HRC) for better and longer cutting power.



Shackle key opener

Dia 9 mm

The secured sheath enables the knife to be positioned in all situations. The sheath offers many fastening points : personally on the sailor (lifejacket, arm, leg), on various locations (cockpit, steering wheel, mast foot, trampoline, catamaran cross beams).

OFFSHORE RESCUE

Part #	10193
	40 mm / 1 37/64
	✓
	✓
	✓
	(Ø12 mm - 15/32)
	★★★★★
	★★★★★
	✓
Stainless steel grade	High hardness
	80g / 2.82 oz

AQUATERRA

YOUR SPORT KNIFE FOR ALL CONDITIONS

The AquaTerra knife is THE must-have knife for practising outdoor aquatic sports such as fishing, motor boating, kayaking or pleasure boating.

Equipped with a stainless steel blade it offers excellent cutting quality and optimal corrosion resistance. Several versions available: smooth blade or smooth blade and corkscrew. This will quickly become an essential tool for all of your sporting activities.



Plain blade



Stainless steel blade: high corrosion resistance



Remarkable cutting power

High resistance handle
Extreme temperatures:
-76°F +148°C



Soft grip



Safety locking blade



Fastening point for wrist loop



3 colors available

Single half-serrated blade model

Part # 10143 / 10144 / 10146



Plain blade with corkscrew model

Part # 10153 / 10154 / 10156

AQUATERRA

Range Part #	Single plain blade	Plain blade with corkscrew
Part # color black	10133	10153
Part # color red	10134	10154
Part # color blue	10136	10156
	✓	✓
	✗	✗
	✓	✓
	✓	✓
	✗	✓
	195 mm / 115 mm - 7 ^{19/32} / 4 ^{17/32}	
	80 mm - 3 ^{5/32}	
	★★★★☆	★★★★☆
	★★★★☆	★★★★☆
Stainless steel grade	X40Cr13 modified	X40Cr13 modified
	60 g - 2.11 oz	68 g - 2.39 oz



Based on castor oil resin & oyster shell powder

AQUATERRA BIO-SOURCED KNIFE

Handle nature with care

Description	N°	Part #	Color	Weight
Smooth stainless steel blade: modified 420 HC Handle: resin made from castor oil + powdered oyster shell. Locking blade. Blade thickness: 2 mm Blade length: 80 mm Total length open/closed: 193 mm / 115 mm	1	Part # 10130	Sandy brown	0.063kg
	2	Part # 10131	Green	



AQUATERRA WOODEN-HANDLED KNIVES

Description	N°	Part #	Weight
Smooth stainless steel blade: modified 420 HC. Carbon fiber & aramid tangs and handle made from olive wood. Locking blade. Blade thickness: 3 mm Blade length: 80 mm Total length: open/closed: 193 mm / 115 mm	3	Part # 10180 Single blade	0.084 kg
	4	Part # 10181 Singleblade/ Corks	0.094 kg



AQUATERRA FISHING KNIFE

LIGHT AND COMPACT

Description	N°	Part #	Color	Weight
Smooth blade - stainless steel 12C27 - Single han opening - Safety locking blade - Corkscrew - Handle with grip Blade thickness : 2mm Blade length : 80mm Total length unfolded / folded : 193mm / 115mm Handle : PA & PU	5	10163	Black/ Grey	0.075 kg
	6	10165	Green/ Grey	



CLASSIC KNIVES

Long knife with leather sheath

1	Part # 10006	Fluorescent Length 20 cm, blade 10 cm	0.094 kg
1	Part # 10007	Fluorescent Length 24 cm, blade 13 cm	0.164 kg

Floating knife, fixed blade with sheath

2	Part # 10009	Length 19 cm, blade 7 cm with sheath	0.096 kg
---	--------------	--------------------------------------	----------

Strap cutter

3	Part # 20501	Double stainless steel blade - aluminium handle	0.112 kg
---	--------------	---	----------

KNIFE SHEATHS

N°	Part#	Description	Weight
1	10026	Real leather sheath - For use with Offshore and Aquaterra knives - Snap fastener - Horizontal and vertical carrying - Sea water resistant sheath - colour: black	0,024 kg
2	10027	Real leather sheath - For use with Offshore and Aquaterra knives - Snap fastener - Horizontal and vertical carrying - Sea water resistant sheath - colour: brown	0,024 kg
3	10022	Cordura® sheath - For use with Offshore and Aquaterra knives - Velcro® strap - Horizontal and vertical carrying - Colour: black	0.022 kg
4	10028	Sheath for Offshore Rescue knife (part.#10192) Many fastening points - Glows in the dark	0.030 kg
5	10029	Sheath for Offshore Rescue Line cutter (part.#10193) - Many fastening points - Colour : black	0.020 kg





Sailing accessories

Tiller extensions, accessories

Wichard designs products which aim at easing the operations and the life on board. They will quickly become essential tools.

Tiller extensions

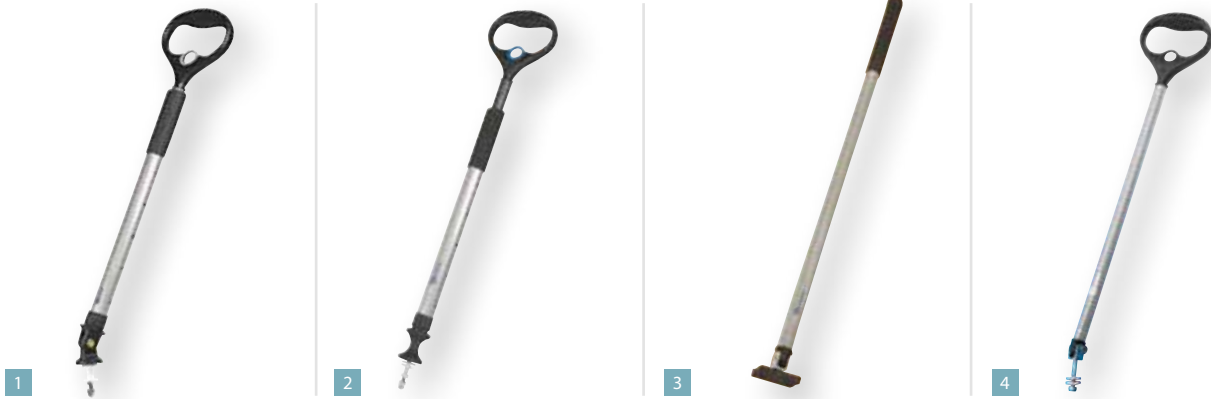

+ BENEFITS

- Large range of tiller extensions
- With or without handle, telescopic or fixed models
- Telescopic models with ball-locking system
- Different joint systems available
- Ergonomic non-slip handles



N°	Part #	Description	Weight kg
TELESCOPIC TILLER EXTENSIONS			
1	7550	Adjustable from 70 to 100 cm	0.682
1	7551	Adjustable from 80 to 120 cm	0.716
2	7555	Adjustable from 70 to 100 cm, stand up rubber articulation	0.708
2	7556	Adjustable from 80 to 120 cm, stand up rubber articulation	0.798
TILLER EXTENSIONS			
3	7510	Length 70 cm - universal ball joint	0.310
3	7520	Length 95 cm - universal ball joint	0.406
TILLER EXTENSIONS WITH HANDLE			
4	7540	Non retractable - length 58 cm	0.378
4	7541	Non retractable - length 70 cm	0.406
RETAINING CLIPS			
5	7500	Retaining clips for parts # 7510, 7520, 7540, 7541 (tube dia. 20 mm)	0.015
6	7501	Retaining clips for parts # 7550, 7551, 7555, 7556 (tube dia. 30 mm)	0.012
SPARE ARTICULATIONS			
7	7504	Spare articulation for parts # 7540, 7541	0,076
8	7505	Spare articulation for parts # 7555	0.146
8	7506	Spare articulation for parts # 7556	0.162
9	7507	Spare articulation for parts # 7550, 7551	0.168
10	7502	Spare articulation for parts # 7510, 7520	0.080



FORTRESS ANCHORS

Wichard offers the range of Fortress anchors for boats from 8 to 21m. The main benefits are: Outstanding holding power, light weight, adjustable fluke angles, easy dismantling and easy handling by any crew member.

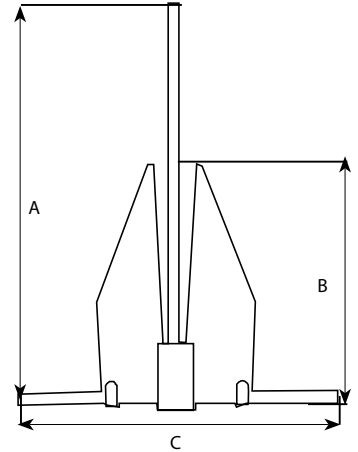

Boat Length m	-8	from 8 to 10	from 10 to 12	from 12 to 14	from 14 to 15,5m	from 15,5 to 18	from 18 to 21	21
Fortress models	FX7	FX11	FX16	FX23	FX37	FX55	FX85	FX125
Working load Kg	315	400	560	900	1350	1800	2350	3040
Weight Kg	2,5	2,9	4,3	6,6	10	15	21	30
Shank length mm (A)	610	686	787	914	1016	1168	1295	1422
Fluke length mm (B)	356	406	457	533	610	686	762	838
Stock length mm (C)	483	559	635	737	813	940	1041	1143
Shackle dia mm	6	6	8	10	12	12	16	16

Supplementary products

Snap hooks - Plastic

N°	Part #	Description
SNAP HOOKS - PLASTIC - POM		
1	MQ00372	Snap hook - size 1 - L: 37 mm - Breaking load: 40 Kg 0.002 kg
2	MQ00502	Snap hook - size 1 - L: 50 mm - Breaking load: 30 Kg 0.003 kg
3	MQ00752	Snap hook - size 1 - L: 75 mm - Breaking load: 50 Kg 0.010 kg
4	MQ1002	Snap hook - size 1 - L: 100 mm - Breaking load: 70 Kg 0.031 kg
5	MD00642	Snap hook - size 1 - L: 64 mm - Breaking load: 20 Kg 0.003 kg



Fairleads

Wichard offers now a complete range of fairleads dedicated to the deviation of furling lines such as ropes for manual-headsail or flying-sail furlers..

N°	Part #	Description	Weight kg
1	20120	Stainless steel single fairlead - For 25mm stanchion Maximum line diameter : 20mm	0.080
2	21020	Stainless steel deck fairlead - M10 screw Maximum line diameter : 18 mm	0.108
3	20220	Stainless steel double fairlead with Velcro stripe for continuous line. For 25mm stanchion maximum - Maximum line diameter : 20 mm	0.180
3	21220	Stainless steel double fairlead with Velcro stripe for continuous line. For 28mm stanchion maximum - Maximum line diameter : 20 mm	0.225
4	21120	Stainless steel articulated fairlead - For 25 & 28mm stanchion maximum - Maximum line diameter : 20 mm	0.110
5	20320	Deck fairlead - Fitting with 2 M5 screws Max rope size : 18 mm - Duplex stainless steel grade	0.063



1



2



3



4



5



Anti-torque cable clamps

Part #	Cable size mm	A mm	B mm	L mm	Weight kg
7321	9	8.5	29	56	0.169
7322	11	10	31	60	0.198
7323	13	12	35	62	0.243
7324	15	15	40	100	0.525



+ BENEFITS

- For anti-torque cables : dia 9, 11, 13 and 15 mm
- Can be used for gennaker with Marlow ProDrive +
- Can be used for asymmetric spinnakers with most of the anti-torque cables available on the market
- Material : Duplex stainless steel grade

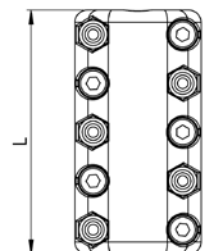
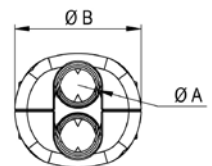

Technical information

Warranty

All Wichard products are warranted to be free of defects in materials or workmanship for five (5) years from the date of purchase by the original end-user. Excluded from this warranty are:

- Any product which has been improperly fitted.
- Any product which has been improperly used or used in any application for which it was not intended.
- Any product which has been improperly maintained.
- Any product modified without a written approval from Wichard.
- Any damage being a consequence from alteration, from ultraviolet light exposure or from the normal wear of products.

The useful life of any products is determined by its utilisation and an appropriate factor of safety (see page 67). It must be distinctly assessed in each application. Thus no guarantee can be provided for product life, dynamic capacities or any other factor due to the variability in usage.

Wichard's liability is limited to the repair or replacement of the defective goods exclusive of any other repair. Responsibility and costs of handling, transportation and any custom duties and tariffs linked to the warranty claim are in any case borne by Wichard.

Corrosion in marine environment

All Wichard products are passivated. Corrosion attacks stainless steel and is always visible in the form of black coloured roughness. Although this is dangerous, it is rarely seen in current use, except in cases where martensitic (HR) steel is in total, prolonged immersion. What many people erroneously call corrosion, is really rust, or oxidation. This is due to outside causes. In the marine environment, stainless steel is subject to considerable aggressive forces and is not totally corrosion free. Re-passivation can be accomplished with a passivator such as Wichinox (see page 8). All stainless steel products demand a minimum of upkeep.

Stainless steel

Wichard uses top-quality grades of stainless steel in its products (see chart). The first type is a low carbon austenitic steel (316L), which offers good mechanical characteristics. They are non-magnetic steels and most of Wichard products are manufactured in this grade. The second (17.4PH) is martensitic steel (magnetic), which is referred to as high-resistance steel (HR).

Type	Austenitic	Martensitic
Common name	18.12 Mo	17.4 PH
European Standard	X2CrNiMo17-12-2	X5CrNiCuNb 16-4
US AISI Standard	316 L	630
Composition Carbon	< 0,03 %	< 0,07 %
Chromium	18 %	16,5 %
Nickel	12 %	4 %
Molybdenum	3 %	
Copper		4 %

Why a Wichard shackle?

A Wichard shackle is manufactured on a very old principal, forging. Wichard has perfected and machined this process down to the smallest detail.

Reliability and high quality

After the raw metal bars are checked on chemical alloy and quality, the metal is heated to the right temperature to be forged. Then the metal is pressed in its new shape with great force by a hydraulic hammer. Due to this process the metal obtains an organized structure without any weakness. Because of this structure, called fibers, the metal object is not only very strong but also has an "elastic" property.

Casted metal objects of the same design are less strong because the structure in the metal is not the same everywhere in the object. Next to this there is the chance that small air bubbles are enclosed during the casting. This causes a capital weakness in the casted object. Even objects machined from a block of metal can have weaknesses. Where the metal is machined into a curve the structure in the metal is broken and becomes a weak point in the object. When the object is overloaded it will break at this point.

Performance and security

Due to the technique of forging every object of the same design and shape has the same properties with a small tolerance of deviation. By controlling all important factors Wichard can guarantee an accurate breaking load and working load for each individual object.

Wichard advises to respect carefully the Working Load (WL) indicated for each of its products. If a Wichard product is overloaded between the safe working load and breaking load the product will deform due to its "elastic" property. This gives the user an extra safety margin and shows when the product is overloaded. Deformed parts have to be replaced immediately preferably by a part in a larger size.

Definitions

Working Load (WL) indicates the value of static load at which the product will still function without excessive friction or wear or permanent deformation of components.

Breaking Load (BL) indicates the value of static load for which a major failure of one or some structural components or the complete destruction of the product can be expected when new. Plastic components may split, rivets may give way, shackles or any other connection parts break and other metallic components may fracture.

Units of load

Our resistance values are shown in kilogramme-force (symbol: kgf or more usually kg), which is the force due to gravity sustained by a mass of 1 kg situated at the latitude of Paris. This unit of force is obsolete, and is not part of the SI international system of units, which links concepts of mass and weight. The unit of force used in the SI system is the Newton (N).

To pass from the kilogramme-force to the Newton its value must be multiplied by g , the acceleration of gravity, which is 9.80665 m/sec^2 at the latitude of Paris, or $9.80665 \text{ N} (\text{N} = \text{kg} \times \text{m} \times \text{s}^{-2})$. In the fields where the kgf appears we should now use the decanewton (or dekanewton), daN: $1 \text{ kgf} = 9.80665 \text{ N} = 0.980665 \text{ daN}$ ($1 \text{ daN} = 1.019716 \text{ kgf}$).

Our test equipment measures loads in daN, but bowing to custom and for reasons of simplicity and safety, we still give values in kgs in our brochures and on our products. Our measured values have simply been converted into kgs.

Factor of safety

Before choosing or specifying a particular product, an appropriate factor of safety should be applied to Breaking Loads (BL) to suit each application.

For many industrial and safety applications, and for some yachting application, a factor of safety greater than two (2) should be used or may be required by law or other regulations. It is the customer's responsibility to ensure that an appropriate factor of safety is used, and it should take into account safety implications, service life, fatigue (as may be caused by wave action, wind stress or repetitive cyclical loading), type of load, exposure to ultraviolet light, corrosion and stress corrosion (such as in high humidity or high chlorine environment). Even more attention is required when specifying blocks as other factors have to be taken into account such as rotary speed, deflection angle of the rope or the number of wire of the tackle (see page 31 of the present document). Note that a "Safe Working Load" is not specified as this is dependent on the factor of safety, which must be determined by the user relative to each application.

In any case, never use the products over the working load !

Useful life

The useful life of any products is determined by the above factors and must be assessed in each application. Thus no guarantee can be provided for product life, dynamic capacities or any other factor due to the variability in usage. In some jurisdictions government regulations require the replacement of rigging components within certain periods of time, usually after three or five years. You must ascertain whether any such regulations affect you and take appropriate steps if you are affected.

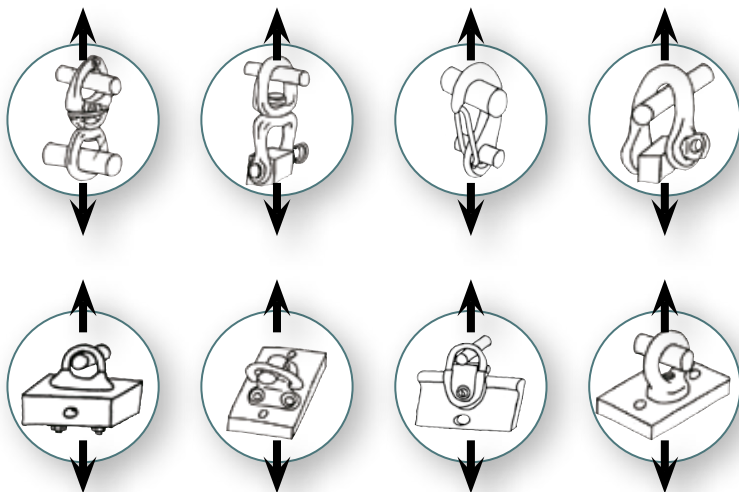

Maintenance and inspection

All your marine hardware, blocks and equipments must receive regular inspections to prevent any deformation, wear, cracks or corrosion. Even if your products have had little use, ultraviolet light exposure, wave action, humid or saline environment may cause damage that could affect quality or strength of the equipment. If, after inspection, you are in doubt about the integrity of one of some parts, it is the customer's responsibility to replace the defective components or product to ensure his own safety.

While every precaution is taken in the product design and manufacturing processes of our products to minimize the effects of corrosion or stress corrosion, appropriate preventive or corrective treatments must be carried out to the products after installation.

Contact

Refer to the distributor list on our website: www.wichard.com

Country	Company	Zip code	City	Area code	Phone	E-mail
Austria	Alltechnik	2362	Biedermannsdorf	43	2 23 664 676	office@allroundmarin.com
Austria	Robert Lindemann KG	20537	Hamburg	49	40 211 197-0	info@lindemann-kg.de
Belgium	Plaisance Diffusion	1030	Brussels	32	0 2 216 79 34	info@plaisance.be
Belgium	Technique Voile	4432	Alleur	32	0 42 63 4041	info@technique-voile.be
Belgium	West Diep Yachting Center	8620	Nieuwpoort	32	58 234 061	info@westdiep.com
Belgium	Wittevrongel Sail	8370	Blankenberge	32	50 411 863	ian@wittevrongel.be
Belgium	Wittevrongel Rigging	8370	Blankenberge	32	0 49 62 8 45 76	steve@wittevrongel.be
Belgium	Seashop	8620	Nieuwpoort	32	0 58 62 50 77	info@seashop.be
Belgium	La Corderie	1050	Brussels	32	0 26 40 72 47	seb@cordage.be
Brazil	Rio Sail Tech	22290-240	Rio de Janeiro	55	254 202 33	contato@riosailtech.com.br
Canada	WPG Canada	J0B 3G0	Stoke (Quebec)	1	819 878 30 18	info@wichard.ca
Canary Islands	Nordest	38001	Santa Cruz Tenerife	34	9 22 577 322	nordest@nordest-canarias.com
China	Sunrise Marineware Ltd		Shenzhen	86	755 866 50 101	sales@sunrisemw.com
Croatia	Aspar - Rigging	51 000	Rijeka	385	51 343 230	aspar-rigging@ri.t-com.hr
Denmark	Columbus Marine	4621	Gadstrup	45	46 19 11 66	columbus@columbus-marine.dk
Finland	Oy Maritim AB	00210	Helsinki	358	10 2740 320	maritim@maritim.fi
French Polynesia	Tahiti Sport/Nauti Sport	98713	Papeete	689	50 59 59	tahiti.sport@tahiti-sport.pf
Germany	Robert Lindemann KG	20537	Hamburg	49	40 211 197-0	info@lindemann-kg.de
Greece	Tecrep Marine	18536	Piraeus	30	14 521 647	sales@tecrepmarine.gr
Greece	Theodosiadis Kiriakkos	18545	Piraeus	30	21 04 205 890	info@theodosiadis.gr
Greece	Nautilus	17455	Alimos / Athènes	30	21 09 854 238	info@nautilus.gr
Greece	Synodinos	18545	Piraeus	30	21 04 17 07 09	info@synodinos.gr
Hong Kong	Storm Force Marine Ltd		Hong Kong	852	2866-0114	sales@stormforcemarine.com
Hungary	Marina Yacht Sport Kft	1078	Budapest	361	3 228 655	bolt@marina.hu
Italy	C-Marine S.r.l.	19031	Bocca di Magra - SP	39	0187 67 08 28	info@cmarine.it
Japan	Marine Services Kojima	236-0003	Kanagawa	81	4 57 903 581	toiawase@mskojima.co.jp
Malta	Gauci Borda & Co Ltd	GZR03	Gzira	356	2131 3758/3748	info@gauciborda.com
Netherlands	On Deck BV	2156 MX	Weteringbrug	31	71 331 33 66	allhands@on-deck.nl
New Caledonia	Marine Corail	98845	Nouméa	687	27 58 48	info@marine-corail.nc
New Caledonia	Boniface ACMA	98863	Nouméa	687	28 28 10	vente@acma.nc
New Zealand	Kiwi Yachting	90114	Auckland	64	9 36 00 30 0	sales@kiwiyachting.co.nz
Norway	Hovdan-Poly A/S	0614	Oslo	47	23 14 12 60	post@hovdan.no
Poland	Majer Na Fali	01-971	Warsaw	48	533 655 095	office@majernafali.pl
Portugal	Luiz Godinho	1400-287	Lisbon	351	2 13 017 753	luizgodinho@iol.pt
Portugal	Lisnautica Lda	1300-340	Lisbon	351	213 639 084	lisnautica@gmail.com
Portugal	DND Lda	1300-598	Lisbon	351	351 213 619 530	dnd@dnd.pt
Portugal	Peter Keeping Unipessoal Lda	8800-166	Tavira	351	281 971 179	info@just-boats.net
Russia	Fordewind-Regatta Ltd	197110	St Petersburg	7	8 124 584 455	office@fordewind-regatta.ru
Singapore	Intermarine Supply Co	639078	Jurong	65	68 633 966	admin@intermarine.com.sg
South Africa	Manex & Power Marine	7420	Paarden Eiland	27	021-511 7292	manex@manex.co.za
Spain	Flint Suministros S.L.	46200	Valencia	34	962 542 088	info@flint.es
Sweden	Liros Skandinavia AB	42750	Billdal	46	31 91 52 00	info@lirosropes.se
Switzerland	Bucher & Walt SA	2072	St Blaise	41	3 27 559 500	info@bucher-walt.ch
Thailand	Sail in Siam Co Ltd	20250	Chonburi	66	818 375 507	info@sailsiam.com
Turkey	Marintek	34700	Istanbul	90	2 163 171 010	info@marintek.com.tr
Turkey	UTL - Skiper	34450	Sanyer/Istanbul	90	212 202 73 46	info@skiper.org
United Kingdom	Pro-Boat Ltd	CM0 8TE	Burnham-On-Crouch	44	(0) 1621 78 54 55	sales@proboat.co.uk



Wichard France
1, ZI de Felet - CS 50085
63307 THIERS cedex FRANCE
Tel: + 33 (0) 4 73 51 65 00
Fax: +33 (0) 4 73 80 62 81
marine@wichard.com

Technical support /
After Sales Service / Hotline
Z.A Pornichet Atlantique
16 av du Gulf Stream
44380 Pornichet - FRANCE
Tel: +33 (0) 2 51 76 00 35
hotline@wichard.com

Wichard North America
3901 Pine Grove Circle Charlotte
NC 28206 - USA
Tel: + 1 (401) 683-5055
Fax: + 1 (802) 655-4689
usasales@wichard.com

Wichard Pacific PTY LTD
PO Box 104 St Peters
NSW 2044 AUSTRALIA
Tel: + 61 2 9516 0677
Fax: + 61 2 9516 0688
info@wichard.com.au